

Nonaromatic Aminium Radicals

YUAN L. CHOW,[†] WAYNE C. DANEN,^{*} STEPHEN F. NELSEN,^{††} and DAVID H. ROSENBLATT^{†††}

Departments of Chemistry, Simon Fraser University, Burnaby, British Columbia, Canada V5A 1S6, Kansas State University, Manhattan, Kansas 66506, and University of Wisconsin, Madison, Wisconsin 53706, and Department of the Army, U.S. Army Medical Bioengineering Research and Development Laboratory, Fort Detrick, Frederick, Maryland 21701

Received February 6, 1978

Contents

I. Introduction	243
II. Generation	243
A. Chemical Methods	243
B. Electrochemical Oxidations	245
C. Photolytic and Thermal Methods	245
D. High-Energy Radiation Methods	246
E. Photosensitized Electron Transfer	246
III. Spectral Properties and Energetics	247
A. Spectral Properties	247
1. ESR Spectra	247
2. Electronic Spectra	251
B. Experimental Redox Energetics	251
1. Electrochemical Measurements	251
2. Ionization Potentials	253
3. Data Correlations	254
4. Factors Contributing to Aminium Radical Lifetimes	254
IV. Chemical Reactions Involving Nonaromatic Aminium Radicals	255
A. Acid-Base Reactions	255
B. Kinetic Behavior	255
C. Amine Oxidations: Pathways, Mechanisms, and Kinetics	256
1. Open-Chain Amines	256
2. Oxidative Fragmentation Reactions	257
D. Hydrogen Atom Abstractions	259
1. Intramolecular Reactions	259
2. Intermolecular Reactions	259
E. Addition to Olefins	262
1. Intermolecular Processes	262
2. Intramolecular Processes	267
F. Aromatic Amination	268
G. Other Reactions	268
H. Reactions of Electrogenerated Nonaromatic Aminium Radicals	270
V. References and Notes	271

I. Introduction

Nonaromatic aminium radicals, $R_3N^{\cdot+}$, are well-established transient intermediates. Unlike their long-lived aromatic counterparts, nonaromatic aminium radicals are difficult to observe by spectroscopic methods. With modern techniques, however, their existence has been demonstrated and their properties measured.

Nonaromatic aminium radicals seem to have first appeared in a reaction mechanism proposed in 1950 by Wawzonek and

Thelen¹ for the Hofmann-Löffler preparation of *N*-methylgranatamine. Nonaromatic and related aryldialkylaminium radicals were postulated at about the same time by Horner² to explain the effects of a series of oxidants on tertiary amines. Thus, their existence was inferred on purely mechanistic grounds a full decade before $NH_3^{\cdot+}$,³ and $(CH_3)_3N^{\cdot+}$,⁴ trapped in salt matrices were observed by electron spin resonance spectroscopy. Since these beginnings, the literature has grown extensively. References to aspects of nonaromatic aminium radicals have appeared in several chemistry review articles,⁵⁻¹² but with emphasis placed in other directions. It is the purpose of this review to present a balanced picture of the various facets of this chemistry. The literature coverage is quite thorough for many aspects of the topic, but an exhaustive compilation was not intended.

II. Generation

Aminium radicals are generated by amine oxidation and by the reduction or disproportionation of oxidized forms of amines.

A. Chemical Methods

1. Oxidation of Amines

Amines can be oxidized by either two- or one-electron processes. In particular, amine oxide or hydroxylamine formation is evidence of two-electron transfer pathways in amine oxidations by hydrogen peroxide,¹³ peroxy acids,¹³ ozone,^{13,14} and other reagents. The mercuric acetate oxidation of a variety of cyclic tertiary amines to enamines is believed to occur with the concurrent two-electron reduction of mercuric ion to metallic mercury; the latter is then oxidized by mercuric to mercurous ion.¹⁵ Permanganate oxidation of benzylamine may occur, at least partially, by a two-electron mechanism.¹⁶ Electron pair transfer is also the likely explanation for tertiary amine oxidations by cyanogen bromide,¹⁷ aqueous bromine,¹⁸ and nitrous acid.¹⁹

One-electron oxidation steps can be inferred for various reasons in the interactions of a number of oxidants with amines. Far more common are reactions that have been attributed to hydrogen atom transfer, which lead directly to a neutral radical intermediate capable of undergoing further oxidation^{16,21-25} or of coupling.^{27,28} This review is concerned, however, with those instances where the evidence supports aminium radical intermediates that result from the oxidation of nonaromatic amines.

Chemical generation of aminium radicals may be divided into two general modes. In the first of these, a one-electron reagent (or a reagent acting in such a manner) directly removes an electron from an amine:

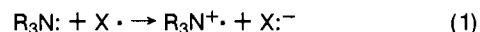

* Author to whom correspondence and reprint requests should be addressed at Kansas State University.

[†] Simon Fraser University.

^{††} University of Wisconsin.

^{†††} U.S. Army Medical Bioengineering Research and Development Laboratory.

The following oxidants have been shown to generate aminium radicals from alkyl- or arylalkylamines in this fashion: alkaline ferricyanide,²⁶⁻³² iron(III) complexed with various substituted phenanthrolines,³² octacyanomolybdate(V),³² permanganate,³³ and chlorine dioxide,^{32,34-41} all in water, *N*-bromosuccinimide in carbon tetrachloride,⁴² and *N*-chlorobenzotriazole in benzene.⁴³

A vinylamine was claimed to undergo iron- or copper-catalyzed oxidation by molecular oxygen in benzene-methanol, via an aminium radical.⁴⁴ Several vinylidenebis(dialkylamines) in acetonitrile formed aminium radical intermediates on oxidation with silver ion.⁴⁵ One might also include nitrogen dioxide in carbon tetrachloride^{46,47} among oxidants of this class, even though dialkylanilines happened to be the subjects of investigation and the intermediates formed were $\text{Ar}\dot{\text{N}}^+\text{R}_2$, rather than $\text{R}_3\dot{\text{N}}^+$.

In the second mode, the bond between a nitrogen-centered cation and a chlorine atom is formed heterolytically and broken homolytically in close sequence. This is similar to other examples of aminium radical generation, to be discussed later, which also entail bond-breaking. The question of homolytic vs. heterolytic bond-breaking in the oxidation of trialkylamines by chlorine or hypochlorous acid occasioned sharp controversy. Although the heterolytic process was favored by some,^{48,49} Horner^{2,50} proposed reaction 2 based on evidence for radical formation, namely, initiation of acrylonitrile polymerization in aqueous solution.

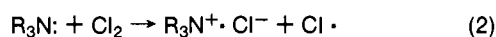

The pathway could easily accommodate $\text{R}_3\text{NCl}^+\text{Cl}^-$ as an intermediate. Since R_3N^+ produced by the reaction of chlorine dioxide with acrylonitrile does not initiate this polymerization,³⁴ it is likely that the initiation is due to the chlorine radicals. It is noteworthy that Deno⁸ has reported a Hofmann-Löffler type reaction via $\text{R}_3\text{NCl}^+ \rightarrow \text{R}_3\text{N}^+$, etc. With an amine of favorable structure, the homolytic reaction in aqueous solution may assume considerable importance, as in the chlorinolysis of triethylenediamine. Here *N*-chloronium compound 1 forms the red cation radical 2^+ (Dabco⁺) in sufficiently high concentration for the radical to show a strong ESR spectrum.^{37,39,51,52} Whereas 1 is highly unstable with respect to 2^+ , and probably to heterolysis as well, the corresponding *N*-chloroquinuclidinium ion (3)

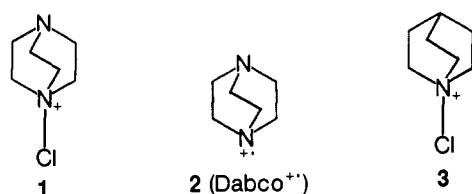

is a remarkably stable species⁵³ and shows no tendency to decompose by either homolytic or heterolytic pathways.

Horner and Kirmse⁵⁴ studied the oxidation of trialkylamines with dibenzoyl peroxide in chloroform. The mechanism is essentially the same as with dialkylanilines involving formation of the aminium radical and the benzoyl radical:^{54,55}

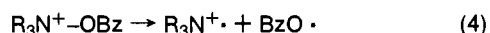
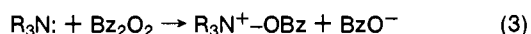

2. Reduction of Amine Oxides

Ferrous ion catalyzed dealkylation of trialkylamine oxides is interesting since the process has been suggested to be responsible for oxidative dealkylation of amines in plant and animal metabolic pathways.⁵⁶⁻⁶² Involvement of aminium radicals as the reactive intermediates has been supported by the observed reaction patterns, namely, polymerization of ethyl methacrylate,⁶¹ addition to butadiene,⁶² and oxidation of cyclohexane to

cyclohexanol,⁶³ and of cyclohexanol and benzyl alcohol to the corresponding carbonyl compounds.⁶¹ Ferrous ion was shown to be the reducing species responsible for initiating the aminium radical formation,⁶² but other metal ions, such as ruthenium, osmium, and vanadium, no doubt can also serve as initiators.⁵⁷ The similarity of pH effects on the direction of dealkylation by chlorine dioxide and Fe^{2+} has been claimed to indicate the involvement of a common intermediate, namely, a trialkylaminium radical^{20,35,36,62,304} (eq 5 and 6). Mechanistically, the reaction

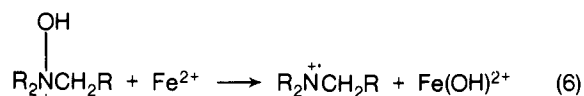
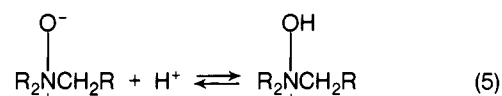

is similar to the benzoyl and cyclic phthaloyl peroxide oxidations reported by Horner and co-workers^{47,54,64,65} and to the thermal decomposition of *N*-chlorotrialkylammonium ions;^{8,66} metal-catalyzed decomposition is, however, much more complex and sensitive to the reaction conditions.

3. Metal-Catalyzed Decomposition of Amine Derivatives

It had been reported in the early literature that titanous salt catalyzed decomposition of hydroxylamine⁶⁷ in acidic conditions may initiate addition to olefins⁶⁸ and benzene⁶⁹ and polymerization of vinyl compounds.^{67,70} The aminium radical was suggested (eq 7), rather than the neutral amino radical, as the reactive intermediate. Corey and Hertler⁷¹ have observed that reaction of *N*-chlorodialkylamines in H_2SO_4 -AcOH solution (Hofmann-Löffler reaction;^{5,7} vide infra) can be initiated by ferrous ions and concluded that aminium radicals are the reactive intermediates which mediate the chlorine- δ -hydrogen exchange reaction (eq 8). Mechanistically, the initiation step is similar to the generation of hydroxyl radical from ferrous ion catalyzed decomposition of hydrogen peroxide (Fenton's reaction): $\text{H}_2\text{O}_2 + \text{Fe}^{2+} \rightarrow \text{HO}\cdot + \text{Fe}(\text{OH})^{2+}$. Minisci and co-workers^{9,10,75-77} have extended this reaction by applying other metal ions, such

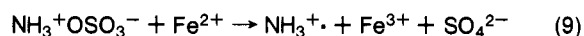
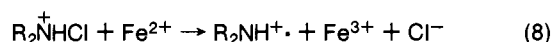
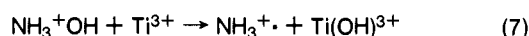

as Cu^+ , and V^{3+} and hydroxylamine *O*-sulfonic acid^{10,75,76} (eq 9) and studied aromatic amination, selective chlorination of alkyl chains, and addition to olefins.^{7,9,10,75} Not only the initiation steps, but also the chain propagations¹⁰ of the Hofmann-Löffler and intermolecular chlorinations and homolytic amination reactions (discussed in more detail in section IV) involve aminium radicals. The variety of reaction conditions ranges from dilute acid in methanol to several molar H_2SO_4 in acetic acid. Since the pK_a of dimethylaminium radical has been determined to be 6.5-7.5 (see section IV.A) aminium radicals must be the reactive species which undoubtedly exhibit electrophilic characteristics in their radical reactions. It is remarkable that some reactions are conducted in heterogeneous phases because of the highly acidic media; the effects on the aminium radical reaction, however, appear to be insignificant.

Similar to the previously discussed amine oxide decomposition, the metal ion catalyzed decompositions described above are highly sensitive to conditions, redox potential of metal ions, and ligands. In particular, side reactions as shown in eq 10 and 11 may interfere extensively to complicate overall reaction patterns.

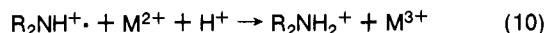

Corollary to the discussion of aminium radicals, *metal ion coordinated* amino radicals must be mentioned since they exhibit closely related electrophilic radical reactivity, including addition to butadiene and simple olefins.⁷⁸⁻⁸¹ Early work⁷⁸⁻⁸¹ by Minisci's group was conducted in neutral solution, wherein metal ion coordinated amino radicals, $R_2N-Fe(Cl)^{2+}$, were proposed as the reactive intermediates. Since a neutral amino radical has been shown to preferentially undergo hydrogen atom abstraction over addition to olefins,^{82,83} the proposal of such a complex as an actual intermediate appears a rational choice. Evidence for such species can be found in the clean cis-chloroamination of cyclohexene^{78,81} (vide infra).

Tetramethyltetrazene-metal salt complexes were believed for years to have the symmetrical bis(dialkylamino)-coordinated structure **4**, leading to the expectation that photolysis would generate the coordinated diradical **4a**. Although photolysis of

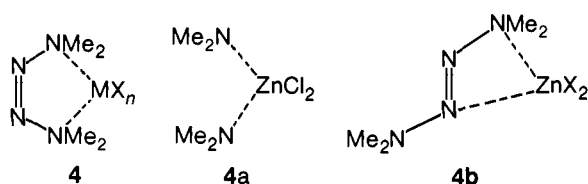

the zinc chloride complex in styrene does give a low yield of the bis(dimethylamino) adduct, bis-addition was not detected with simple olefins,⁸³ and the crystal structure^{83a} of another zinc salt complex showed that the complex has the unsymmetrical structure **4b**.

It should be cautioned that under weakly acidic or neutral solutions chloramines readily undergo complex decomposition to yield chlorinating and oxidizing species, such as Cl_2 and $RNCl_2$ that could complicate the reaction pattern. Such competing dark reactions can be minimized by using inverse addition of a chloramine solution to an olefin-metal salt solution.⁷⁸

B. Electrochemical Oxidations

The products of electrolytic oxidation of alkylamines have received considerable study,⁸⁴ and the formation of an amine cation radical by one-electron transfer to the electrode has been almost universally invoked as the first step in such oxidations. Only in a handful of special cases (see section III.B.1) has the initially formed cation radical been sufficiently long lived to allow its detection, and the primary thrust of electrochemical amine oxidation studies has been either to investigate the energetics of the redox reaction (section III.B.1) or to study how the final product mixture depends upon conditions and amine structure. In simple cases, oxidative dealkylation processes predominate, because the amine radical cation ($A^{\cdot+}$) deprotonates at the α -carbon, and the α -amino radical formed ($B\cdot$) is oxidized to the immonium salt which hydrolyzes to the dealkylated amine and a carbonyl compound (eq 12).^{85,86}

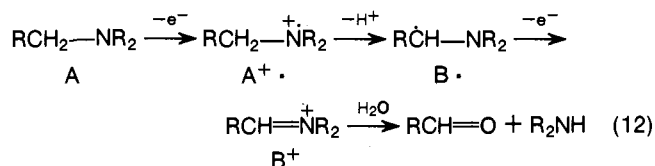

One important structural effect involves the fact that α -deprotonation is far slower when the C-H protons are forced to lie nearly perpendicular to the charge-bearing orbital in the amine cation. Mann and co-workers⁸⁷ have shown that nortropane **5** is oxidized in acetonitrile containing solid sodium hydride to give the *N*-formyl compound **7** and a lesser amount of the urea **8**, both of which are argued to arise from the solvent adduct **6**, formed

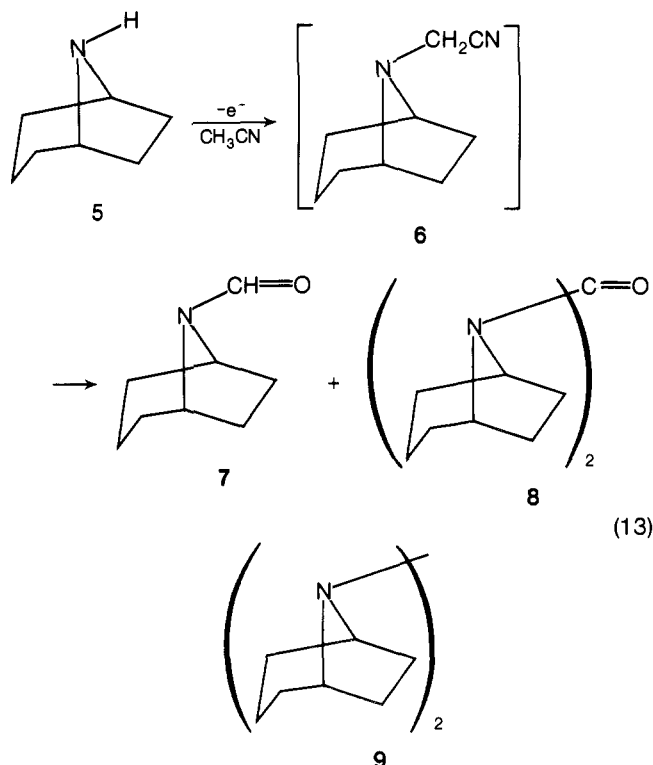

by coupling of nortropane radical and $NCCH_2\cdot$ (eq 13). In benzonitrile, the nortropane radical dimer **9** is the major product (58%),⁸⁷ although it was always a very minor product in acetonitrile. It is clear that α -deprotonation is not an important decomposition mode for $5^{\cdot+}$ in contrast to the case for most aminium radicals.

C. Photolytic and Thermal Methods

1. *N*-Haloamines

Thermal or photolytic decomposition of haloamines in highly acidic media, e.g., ~ 2 M H_2SO_4 in acetic acid, was originally established as the Hofmann-Löffler reaction⁵⁻⁸ and was the first reaction in which aminium radicals were implicated as the radical chain carriers (see section IV.D.1).^{1,89} Subsequent investigations by other groups have established that aminium radicals generated in a similar way exhibit unusually high selectivity in abstracting ω -1 hydrogen atoms from alkyl chains^{8,66,90} and show a propensity toward addition to carbon-carbon multiple bonds (see section IV).⁷ Although thermolysis can start the chain reaction, irradiation with light of >280 nm (Pyrex filter) or use of radical initiators (peroxides or bisazoisobutyronitrile) accelerates⁹⁰ and oxygen quenches the reaction.⁷¹ Since protonated chloramines absorb negligibly at the wavelengths utilized, controversy exists as to the real entity that initiates the homolysis.⁹¹ Dark reaction products, such as Cl_2 and $RNCl_2$, have been suggested to be the initiator(s)⁹⁰⁻⁹² in chloramine photodecomposition. Photolysis or other initiation accelerates the aminium radical chain reaction so rapidly that the competing dark reactions are minimized to give cleaner and higher yields of the desired reaction.

Inasmuch as the occurrence of aminium radicals seems reasonable in the radical-initiated and photolytic decomposition of chloramines, caution must be exercised in thermolyses since heterolysis of chloramines in highly acid media⁹³ may give nitrenium ions (eq 14a, singlet or triplet) which may serve as the reactive intermediates.⁹⁴ Indeed, an aluminum chloride catalyzed reaction (Friedel-Crafts conditions)⁹⁵ would not allow a ready distinction between involvement of an aminium radical or a nitrenium ion (eq 14b).

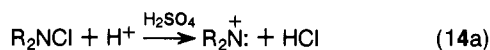

2. *N*-Nitrosamines

Generation of aminium radicals by nitrosamine photolysis in weakly acidic (pH ~ 1–3) aqueous alcohol¹¹ is an interesting reaction from a mechanistic point of view. Significantly, neither thermolysis of nitrosamines in the condensed phase nor photolysis in neutral solution causes the homolysis of the N–N bond, owing to its partial double bond character.^{97,98} Extensive research by Chow's group has indicated that a nitrosamine–acid complex⁹⁹ decays from the lowest singlet excited state to the *N*-nitrosammonium ion (ground state), which thermally or photolytically dissociates to an aminium radical and nitric oxide (eq 15). Studies by flash excitation of both *N*-nitroso and *N*-chloro-

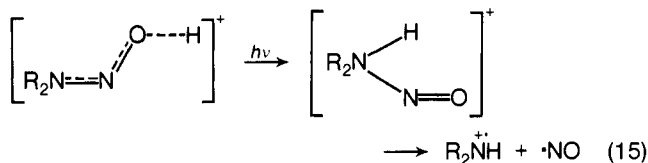

piperidine in dilute acidic solution and by comparisons of decay kinetics have demonstrated that a common transient, the piperidinium radical, is involved.^{99,100}

Despite the vastly different conditions for conducting the preparative experiments, the reaction patterns of nitrosamine photolysis approximately parallel those of chloramine photolysis with notable exceptions (vide infra). Synthetically, simplicity of experimentation and mild conditions may give nitrosamine photolysis significant advantages over chloramine photolysis. However, since nitrosamines are *proven carcinogens to animals*,¹⁰¹ the user must exercise utmost safety precautions in handling the chemicals.

3. *N*-Nitroamines

Photolysis of *N*-nitroamines in dilute acid solution has been shown to generate the corresponding aminium radical (eq 16a)

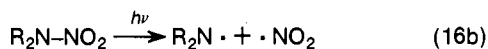
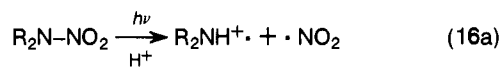

since the expected addition products to olefins via a radical pathway have been obtained.^{72,73} Similar photolysis under neutral conditions (eq 16b) failed to give any addition product in the presence of the same olefins. Together with the tetramethyl-2-tetrazene decomposition to be described below, these results demonstrate the reactivity difference between aminium and amino radicals; i.e., aminium radicals efficiently add to a carbon–carbon multiple bond but amino radicals do not.⁸²

4. 2-Tetrazenes

Acid-catalyzed thermal decomposition of 2-tetrazenes has been proposed to give aminium radicals as intermediates which may undergo complex oxidation processes to generate various radicals.^{74,88,96} Recently, it was shown that photolysis of tetramethyl-2-tetrazene in the presence of trifluoroacetic acid generated the dimethylaminium radical which efficiently attacked olefinic bonds.¹⁷⁹

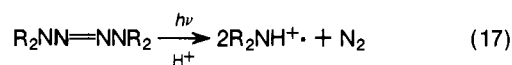

Similar to nitroamine photolysis, tetramethyl-2-tetrazene photolysis under neutral condition fails to give any addition product to olefins supporting the conclusion on reactivity of amino radicals reached above.

Photolytic generation of aminium radicals from nitrosamines, nitroamines, and tetrazenes has a common feature in that neither the excited state reactions nor aminium radical reactions are quenched by oxygen.

D. High-Energy Radiation Methods

1. Radiolysis

Aminium radicals are frequently formed in high-energy radiolysis of amines. The radiation chemistry of water and aqueous solutions is known to produce OH radicals, H atoms, and hydrated electrons (e^-_{aq}), in addition to H_2 and H_2O_2 .¹⁰² Simic and Hayon¹⁰² have shown that e^-_{aq} reacts rapidly ($1.2 \times 10^{10} M^{-1} s^{-1}$) with protonated hydroxylamine to produce the parent nonaromatic aminium radical, NH_3^+ .

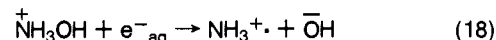

A similar reaction takes place with *O*-methylhydroxylamine.

Fessenden and Neta¹⁰³ have observed $(CH_3)_2NH^+$ and $(CH_3)_3N^+$ by ESR upon irradiation of acid solutions of di- and trimethylamine with high-energy electrons. The aminium radicals were formed by attack of $HO\cdot$ on the respective ammonium ions (eq 19a). In neutral or basic solutions, amines invariably react

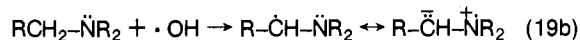
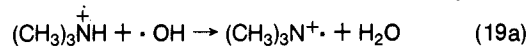

with radiolytically generated $HO\cdot$ to produce aminoalkyl radicals by abstraction of the hydrogen α to the amino group (eq 19b); such a reaction pathway is anticipated because of the resonance stabilizing influence of the lone pair electrons of the attached nitrogen. This type of radical is frequently produced when amino acids, peptides, and proteins are exposed to ionizing radiation in both solution and the solid state.¹⁰⁵

Both Cole^{3a} and Hyde and Freeman^{3b} have reported NH_3^+ in x-ray damaged crystals of NH_4ClO_4 . In a similar manner, Tench⁴ has reported the ESR spectrum of $(CH_3)_3N^+$ produced by γ -irradiation of crystals of $(CH_3)_4NCl$.

It is obvious from the above examples that aminium radicals can be generated by high energy ionizing irradiation of appropriate amine precursors. This is an "overkill" method, however, and generally not a clean source of aminium radicals. This method of generation has been utilized mainly to produce low concentrations of these reactive transients for observation by ESR or UV–visible spectrophotometry and much valuable kinetic and structural data have been obtained.

2. Mass Spectroscopy

Owing to the relatively low ionization potentials of amines, aminium radicals are almost always the initially formed ions in mass spectroscopic studies of such compounds.¹⁰⁶

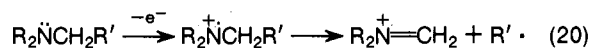

Most aliphatic amines exhibit an easily observable molecular ion (aminium radical) but the base peak frequently results from a β -cleavage of an alkyl radical (eq 20). Since aminium radicals produced in this manner undoubtedly possess considerable excess energy and undergo rapid fragmentation, they are unique and not considered within the scope of this review.

E. Photosensitized Electron Transfer

Electronically excited states of many molecules are rapidly quenched by amines and several lines of evidence point toward

electron transfer, generating aminium radicals, as intermediates in these reactions. This area has been recently reviewed by Cohen and co-workers.¹⁰⁷ Weller's group¹⁰⁸ has contributed considerably to this area, using aromatic hydrocarbons as excited acceptors; much work has also been done with ketones.

Electron transfer from an amine to an electronically excited hydrocarbon or carbonyl compound occurs at the diffusion-controlled rate if ΔG is more exothermic than about 0.5 eV (12 kcal/mol).¹⁰⁹ With aromatic hydrocarbons there is evidence for the formation of an intermediate exciplex which in polar solvents may completely transfer one electron to form a solvated ion pair which consists of an aminium radical in partner with an anion radical:^{281,282}

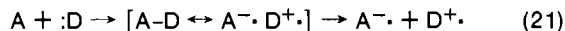

The triplet excited states of aromatic carbonyl compound are also efficiently quenched by the electron transfer mechanism to generate aminium radicals although whether it is a direct transfer or via exciplex is not clear (eq 22).^{283,284} Since the

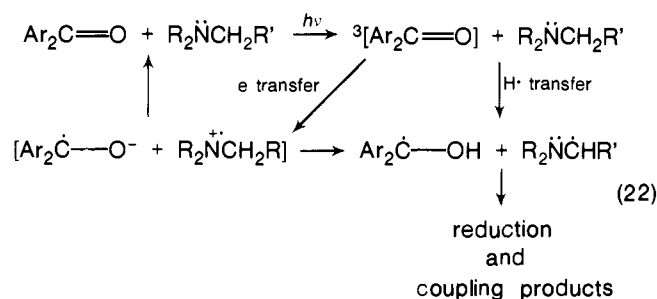

back-transfer of an electron to give ground-state reactants, and proton transfer between the aminium ion and radical anion are both usually rapid, the initial intermediates are short-lived, although both electronic^{108,109} and ESR spectroscopy¹¹⁰ have been used for their detection.

Alkylamines photolytically reduce not only the carbonyl compounds with low-lying $n-\pi^*$ triplet states but also those with low-lying²⁸⁵⁻²⁸⁷ $\pi-\pi^*$ and charge-transfer triplet states;²⁸² the excited states of the carbonyl compounds are quenched at nearly diffusion-controlled rates.²⁸⁸⁻²⁹⁰ These observations led to the proposal of charge-transfer quenching followed by an α -proton transfer as the key step in the photoreduction.²⁸⁸ A direct α -hydrogen abstraction, which leads to the same result, also occurs to a lesser extent in secondary and primary alkylamines.²⁹¹ The major support of the charge-transfer quenching mechanism derives from the observation that quenching rates of fluorenone triplets are linearly correlated with Hammett substitution constants (σ) of substituted dimethylanilines^{292,293} and also with ionization potentials of various donor amines.^{285,294} As expected, the general trend of quenching efficiency is tertiary > secondary > primary amines.

Further evidence for charge-transfer quenching is obtained in the observation of the ESR signals of corresponding ketyl anion radicals when benzophenone is photoreduced by isobutylamine or *tert*-butylamine and fluorenone by triethylamine.²⁹⁵ Although the corresponding alkylaminium radicals could not be detected in these ESR studies, both the benzophenone radical anion (λ_{max} 650 nm) and the dimethylanilinium radical (λ_{max} 480 nm) were recorded during laser flash photolysis in acetonitrile solvent.²⁹⁶ Other aminium radicals have also been identified.^{110,297} The CIDNP observed for 4,4'-disubstituted benzophenones during irradiation in the presence of Dabco also provided evidence for electron transfer from Dabco to the ketones as the quenching step in the photoreaction.¹¹¹

III. Spectral Properties and Energetics

A. Spectral Properties

1. ESR Spectra

a. a^{N} Interactions and Structure

Aminium radicals are isoelectronic with alkyl radicals. Although this results in a similarity of chemical and physical properties, nonaromatic aminium radicals differ from their carbon-centered analogs in several significant respects. Firstly, the central nitrogen atom not only bears a significant spin density but also possesses a formal positive charge which could produce a difference in structure and reactivity for the two types of radicals. Secondly, unlike alkyl radicals, the simple aminium radicals carry a large portion of their unpaired electron density on an ESR-active atom, i.e., ^{14}N ($I = 1$; 99.63% natural abundance).¹⁵¹ This latter feature is particularly appealing to an ESR spectroscopist since the electronic interactions about the central atom can be conveniently monitored without resorting to expensive and time-consuming isotopic enrichment as is usually necessary with ^{13}C for alkyl radicals. Nevertheless, owing to their more frequent occurrence, transient carbon-centered radicals have received considerably more attention by ESR spectroscopists than nonaromatic aminium radicals.

Alkyl radicals are easily deformed species and the unpaired electron can be placed into a hybrid orbital on carbon if electronically compelled by appropriate substituents. In this review we will consider a π radical as one in which the unpaired electron resides primarily in a p orbital on the central atom, e.g., **10**, while a σ radical has the unpaired electron located predominantly in a hybrid orbital with a finite s component. An electronegative substituent or constrained ring system forces s character into the orbital of the unpaired electron. The effect of substituents has been explained both on the basis of electronegativity concepts¹⁵² and conjugative destabilization;¹⁵³ the latter interpretation appears correct.^{153b} The carbon-centered radicals **11-14**

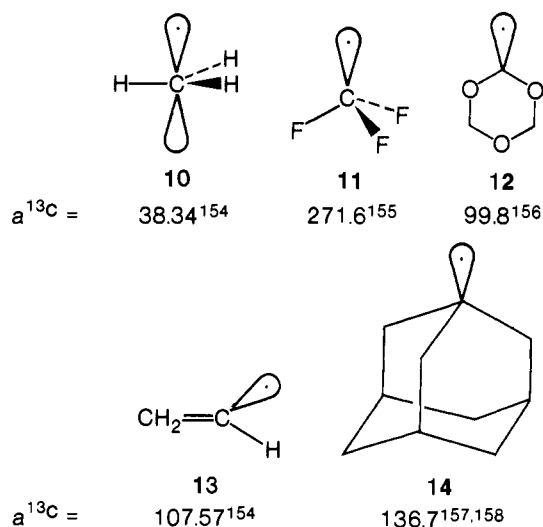

are classical examples of σ alkyl radicals on the basis of large isotopic ^{13}C hyperfine couplings to the central carbon atoms; many other nonplanar alkyl radicals have also been identified.¹⁵⁹

The formal positive charge on the central nitrogen atom in an aminium radical should result in a more rigidly planar, less easily deformed species as compared to the isoelectronic alkyl radical. Semiempirical SCF-INDO-MO calculations¹⁶⁰ support this conclusion and predict that the out-of-plane bending force constant for an aminium radical should be intermediate between that of an alkyl radical and a carbonium ion. Energies of 0.2, 3.2, and 9.7 kcal/mol are calculated as necessary to deform **15**, **16**, and **17** by $\theta = 10^\circ$, respectively.¹⁶¹ With the exception of several

TABLE I. ESR Parameters of Nonaromatic Aminium Radicals

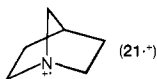
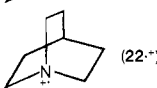
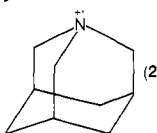
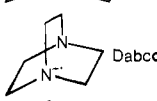
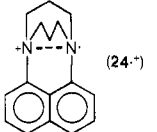
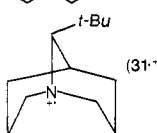
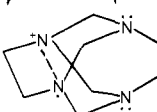
Radical	a^N	a_{NH}^H	a_{β}^H	a_{γ}^H	g	Conditions, ^a temp	Ref
NH_3^+	19.5	25.9			2.0035	$NH_4ClO_4(s)$	3a
	18.1	25.0			2.0034	$NH_4ClO_4(s)$	3b
	19.3	25.8				$NH_4ClO_4(s)$, -196°	164
ND_3^+	18.8	4.03 ^b			2.0035	$ND_4ClO_4(s)$	3a
	17.3	3.6 ^b				$ND_4ClO_4(s)$, 27°	164
$^{15}NH_3^+$	27.2 ^c	25.7				$NH_4ClO_4(s)$, 27°	162
$^+NH_2SO_3^-$	18.2	22.8				$NH_3SO_3(s)$, 27°	172
$(CH_3)_3N^+$	18.0		26.7		2.0044	$(CH_3)_4NClO_4(s)$	4
	20.7		28.5		2.0037	$CF_3SO_3H(l)$ -50 to $+160^\circ$	161
	20.55		28.56		2.00357	$H_2O/HClO_4(l)$	103
	19.28	22.73	34.27		2.0036	90% $H_2SO_4(l)$, 31°	171
$(CH_3)_2\dot{N}H^+$	19.23	21.96	33.61		2.00354	$H_2O/HClO_4(l)$	103
$(CH_3)_2\dot{N}D^+$	19.3	3.52 ^b	34.5		2.0036	90% $D_2SO_4(l)$, 31°	171
$(CH_3CH_2)_2\dot{N}H^+$	18.65	22.24	37.19		2.0036	90% $H_2SO_4(l)$, 31°	171
$(CH_3CH_2)_2\dot{N}D^+$	18.7	3.44 ^b	37.5		2.0035	90% $D_2SO_4(l)$, 31°	171
$(CH_3CH_2CH_2)_2\dot{N}H^+$	18.58	21.81	32.41		2.0036	90% $H_2SO_4(l)$, 31°	171
$[(CH_3)_2CH]_2\dot{N}H^+$	18.7	22.5	21.7	0.80	2.0036	90% $H_2SO_4(l)$, 31°	171
$(CH_3)_3\dot{C}N^+HCH_3$	19.2	22.2	34.5	0.71	2.0036	90% $H_2SO_4(l)$, 31°	171
 (21 ⁻)	30.2	See text for other hfs assignments				$CF_3SO_3H(l)$, -40°	173
 (22 ⁻)	25.1	See text for other hfs assignments				$CF_3SO_3H(l)$, 0°	173
 (23 ⁻)	21.6	See text for other hfs assignments				$CF_3SO_3H(l)$, -50°	173
 Dabco ⁻	16.96		7.34			$CH_3CN(l)$	127
 (24 ⁻)	14.1		22.5 (4 H)			$CH_3CN(l)$, 75°	134
 (31 ⁻)	19.5				2.0041	$CH_2Cl_2(l)$	133
 (25 ⁻)	7.04		7.68 (8 H) 4.14 (8 H)			$CH_3(CH_2)_2CN(l)$, -100°	132

^a (s) = solid or glass phase; (l) = liquid solution. Temperature in $^\circ C$; assume ambient if temperature not noted. ^b Deuterium hfc. ^c ^{15}N hfc.

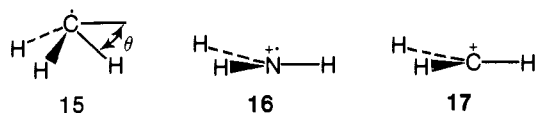

bridgehead aminium radicals to be discussed below, the ESR evidence is consistent with a planar geometry about nitrogen for all nonaromatic aminium radicals reported to date although it will be shown below that a^N is probably not nearly so sensitive to out-of-plane deformation as a^{13C} .

The ESR parameters for well-characterized nonaromatic aminium radicals are reported in Table I. The simplest radical, NH_3^+ , has been studied by three groups of workers^{3,164} who unanimously agree that the radical possesses a planar geometry. The isotropic ESR parameters for the radical "tumbling" in the NH_4ClO_4 matrix at room temperature,³ the anisotropic interactions at 4 K,¹⁶² the a^N/a^{13C} ratio for NH_3^+ vs. $-CH_3$, and comparison of a^N with theoretical calculations^{3,163} are all consistent with a π electronic configuration for NH_3^+ . The insensitivity of a^N

to temperature changes in the -196 to $+25^\circ C$ region¹⁶⁴ compared with the predicted and observed sensitivity of a^{13C} in $\dot{C}H_3$ is in accord with a far greater resistance to bending expected for NH_3^+ .

The trimethylaminium radical, $(CH_3)_3N^+$, has been generated by γ -irradiation of crystals of tetramethylammonium chloride.⁴ Tench concluded that the radical is probably planar although it executed restricted rotation in the host crystal at room temperature. More recent solution studies yielded slightly higher values for a^N and a_{β}^H (Table I). Interestingly, a^N for $(CH_3)_3N^+$ (20.7 G) is larger than for NH_3^+ (18.1–19.5 G) even though in the former an appreciable amount of spin density is removed from the central nitrogen atom to the methyl substituent via hyperconjugation (vide infra). The larger a^N for $(CH_3)_3N^+$ as compared to NH_3^+ then may reflect a more effective $\pi \rightarrow \sigma$ spin polarization for a N–C bond as compared to a N–H bond.¹⁶⁵ It has been demonstrated¹⁶¹ that both a^N and a_{β}^H for $(CH_3)_3N^+$ are independent of temperature within experimental accuracy (± 0.2 G) over the temperature range -50 to $+160^\circ C$ indicating

no significant admixture of 2s character into the wave function as a result of deviation from planarity. A similar difference exists in $a^{13\text{C}}$ in comparing $\text{CH}_3\cdot$ (38.5 G) vs. $(\text{CH}_3)_3\dot{\text{C}}$ (49.5 G); variable-temperature studies have demonstrated that the latter radical is nonplanar.¹⁶⁶⁻¹⁷⁰

The ESR spectra of various dialkylaminium radicals, $\text{R}_2\dot{\text{N}}\text{H}^+$, have been obtained by ultraviolet photolysis of the corresponding *N*-chloramines (eq 23) in 90% H_2SO_4 solution¹⁷¹ (Table I). The dialkylaminium radicals are the conjugate acids of dialkyl-

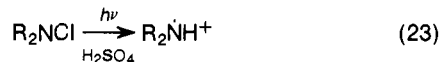

amino radicals, $\text{R}_2\dot{\text{N}}\cdot$, and comparisons of the two types of paramagnetic species were discussed. The most notable features include: (a) a^{N} for $\text{R}_2\dot{\text{N}}\text{H}^+$ (~ 19 G) are considerably greater than a^{N} for $\text{R}_2\dot{\text{N}}\cdot$ (~ 14 G),¹⁷⁴ (b) the methyl hyperfine interaction in $(\text{CH}_3)_2\dot{\text{N}}\text{H}^+$ (34.27 G) is significantly larger than the corresponding interaction in $(\text{CH}_3)_2\dot{\text{N}}\cdot$ (27.36 G); (c) there are less pronounced conformational restrictions in $\text{R}_2\dot{\text{N}}\text{H}^+$ than in $\text{R}_2\dot{\text{N}}\cdot$, presumably because of a greater CNC angle for the former (126° and 117° for $(\text{CH}_3)_2\dot{\text{N}}\text{H}^+$ and $(\text{CH}_3)_2\dot{\text{N}}\cdot$, respectively, from INDO energy-minimized geometries).

The $a^{\text{N}}/a_{\text{NH}}^{\text{N}}$ ratio for the dialkylaminium radicals in Table I was reasonably constant at 0.84 ± 0.02 which was slightly larger, as anticipated (vide supra), than the value of 0.76 for $\cdot\text{NH}_3^+$ but identical with the ratio of 0.84 obtained for several diarylaminium radical cations.¹⁷⁵ The deuterium coupling, a_{ND}^{D} , was within experimental error of that anticipated from a_{NH}^{H} when allowing for the different nuclear moments and spin and a^{N} was not affected by deuteration even though a^{N} decreases by ~ 2 G in going from NH_3^+ to ND_3^+ .¹⁶⁴ All data for the dialkylaminium radicals were consistent with a π electronic configuration.

There are but few reported examples of aminium radicals substituted with electronegative substituents analogous to the carbon-centered species 11 and 12. The SO_3^- group in $^+\text{NH}_2\text{SO}_3^-$ does not affect a^{N} to any significant extent. One of the present authors¹⁶¹ has observed $(\text{ClCH}_2\text{CH}_2)_2\dot{\text{N}}\text{H}^+$ for which $a^{\text{N}} = 19.0$ G, $a_{\text{NH}}^{\text{H}} = 22.0$ G, and $a_{\beta}^{\text{H}} = 35.7$ G. These parameters are similar to those for $(\text{CH}_3\text{CH}_2)_2\dot{\text{N}}\text{H}^+$, indicating that the two γ chlorines are too remote to perturb the geometry. Attempts at generating aminium radicals with more strongly electron-withdrawing groups or the aziridinium radical were unsuccessful.¹⁶¹ Attempts¹⁶¹ to generate $\text{F}_2\dot{\text{N}}\text{H}^+$ by dissolving N_2F_4 in either $\text{CF}_3\text{SO}_3\text{H}$ or $\text{FSO}_3\text{N}-\text{SbF}_5$ produced only the spectrum of $\text{F}_2\dot{\text{N}}\cdot$.¹⁷⁶

Tetraalkylhydrazine radical cations, nitroxides (18), and ketyl radical anions share the property of having a "three-electron π bond". The first two species may in a sense be considered substituted aminium radicals with substituents $-\text{NR}_2$ and $-\text{O}^-$, respectively, the latter because of the charge resonance form 18b for nitroxides. Although the inversion barrier is very low,

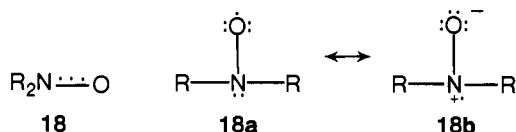

some tetraalkylhydrazine radical cations have been shown to be nonplanar by variable-temperature ESR studies.^{176b} There is both experimental and theoretical evidence for nonplanarity at nitrogen in nitroxides,¹⁷⁷ and there is considerable theoretical evidence that the carbon-centered ketyl radicals have a stronger preference for a pyramidal carbon^{176a} than nitroxide or hydrazine radical cations do for pyramidal nitrogen, in accord with the INDO results discussed above.

Symons et al. have obtained spectra of the imino radical $\text{H}_2\text{C}=\dot{\text{N}}$ in both solid KCl ($a^{\text{N}} = 9.5$ G)¹⁷⁸ and HCN ($a^{\text{N}} = 15 \pm 2$ G).¹⁶⁴ The increased a^{N} value in HCN was attributed to either an enhanced spin polarization upon hydrogen bonding via the

π formulation 19 or a real admixture of 2s character via the σ formulation 20. The former explanation is in accord with other

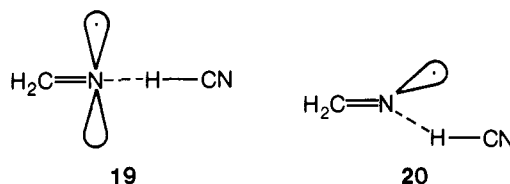

data (vide supra) demonstrating an increase in a^{N} upon protonation of a neutral nitrogen-centered radical but suffers from the nonobservance in the ESR spectrum of the hydrogen-bonded hydrogen although the broad lines in the spectrum might have obscured this coupling. A nonlinear CNH alignment to produce the σ -like radical 20 analogous to the carbon-centered vinyl radical 13, if indeed correct, might be considered an aminium radical with a σ electronic configuration.

The bridgehead aminium radical derived from 1-azaadamantane 23 which is isoelectronic with 14^+ as well as the even more strained species from 1-azabicyclo[2.2.2]octane (22) and 1-azabicyclo[2.2.1]heptane (21) have been reported.¹⁷³ The

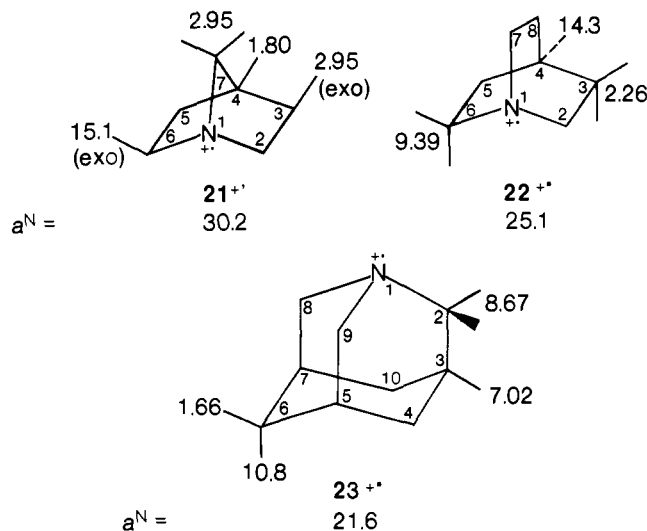

radicals $21^+ - 23^+$ were generated by irradiation of the amine- Cl_2 adducts in $\text{CF}_3\text{SO}_3\text{H}$ solution. Nitrogen hyperfine interactions of 30.2, 25.1, and 21.6 G were observed for $21^+ - 23^+$ respectively, which compared with $a^{\text{N}} = 20.7$ G for the trimethylaminium radical. It was concluded that the cage radicals are pyramidal about their respective nitrogen atoms but that there is a trend toward planarity in going from 21^+ to 23^+ . Complete INDO geometry optimizations for 21^+ , 22^+ , 23^+ , and $(\text{CH}_3)_3\text{N}^+$ indicated that the nitrogen atom is external to a plane defined by the attached three carbon atoms by 0.44, 0.32, 0.30, and 0.0 Å, respectively. Large long-range hyperfine couplings, particularly to the δ hydrogen in 22^+ (14.3 G) and the axial δ hydrogens in 23^+ (10.8 G) were observed, but the coupling to the bridgehead hydrogen in 21^+ was only 1.8 G. Interestingly, movement of the bridgehead nitrogen inward predicts a calculated decrease in a_{H}^{H} for 22^+ but an increase for this proton in 21^+ , suggesting that a through-bond mechanism for spin delocalization is operative in these bicyclic radicals and that a backlobe effect is probably unimportant.

Unlike the radicals $21^+ - 23^+$, the spectrum of the aminium radical derived from Dabco is so easily obtained in a simple flow cell that the ESR detection of this species is the basis of an undergraduate laboratory experiment.⁵² The stability derives from unpaired electron delocalization over both nitrogen atoms as discussed in section III.B. The 16.96-G coupling to the two bridgehead nitrogens and the 7.34-G interaction with 12 equivalent hydrogens¹²⁷ may be compared with 22^+ . Considering

that only "half" of the spin density and charge is associated with a given nitrogen, the a^N indicates appreciable deviation from planarity for Dabco⁺.

Even though **24**⁺ possesses an aromatic ring, it is correctly included in this review because Alder and co-workers¹³⁴ have shown that there is no delocalization of the unpaired electron into the naphthalene moiety because of the orthogonal nature of the requisite orbitals.³⁰⁵ The radical cation is very long-lived, and formed at a low oxidation potential, probably because removal of an electron relieves strain in the bicyclo[3.3.3]undecyl system (even neutral **24** is nearly planar at nitrogen).¹³⁵ The

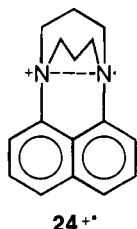

relatively large value for a^N of 14.1 G is consistent with σ^* character in the spin-bearing orbital which will cause the nodes to lie inside the nitrogen nuclei. In the absence of σ^* character, the authors reason that a^N might be expected to be about half that of $(\text{CH}_3)_3\text{N}^{+4}$ or ~ 9 G. However, the relatively electronegative sp^2 orbitals of the naphthalene substituent would result in at least a slightly enhanced a^N as a result of more efficient $\pi \rightarrow \sigma$ spin polarization. Only one proton of each α -CH₂ group is properly aligned for hyperconjugative interaction indicating a rather rigid structure of **24**⁺ even at 75 °C.

The ESR spectrum of **25**⁺ was originally interpreted in terms of all four nitrogens being instantaneously equivalent because of 1,4-through-bond and 1,3-through-space lone-pair interactions.¹³² A more recent interpretation of the electronic ground state of **25**⁺ by Haselbach and co-workers¹¹⁵ utilizing geometry-optimized MINDO/3 calculations indicates a less symmetrical structure **25a**⁺ \leftrightarrow **25b**⁺ with two nitrogens involved in a three-electron bond as was suggested for **24**⁺. However, the

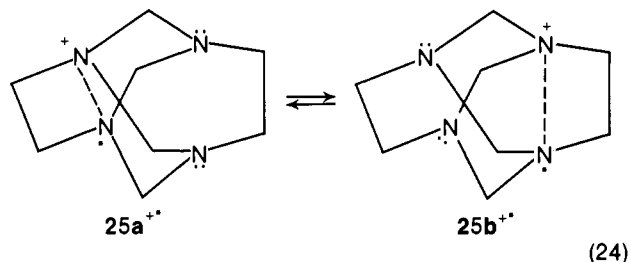

equivalency of the four nitrogens is consistent only with rapidly equilibrating structures necessitating rapid (on the ESR time scale) electron transfer between the sets of NC₂H₄N groups (eq 24).

In summary, aminium radicals appear considerably more rigid than the isoelectronic alkyl radicals. The a^N values were seen to vary from ~ 18 to 19 G for H₃N⁺ and R₂NH⁺ which are planar to 30.2 G for **21**⁺ which is certainly pyramidal about nitrogen. It is also apparent that a^N is not nearly so sensitive to electronic configuration as is a^{13C} (vide infra).

b. a^H Interactions

The a^H couplings in aminium radicals arising from both spin polarization and hyperconjugative mechanisms are generally somewhat greater in absolute magnitude than a^H for the corresponding alkyl radicals. For example, $a_{\text{NH}}^H = \sim 26$ G for NH₃⁺ vs. $a^H = 23.04$ G for $\dot{\text{C}}\text{H}_3$ but $a_{\text{NH}}^H = 22.73$ G for $(\text{CH}_3)_2\dot{\text{N}}\text{H}^+$ vs. $a_{\alpha}^H = 22.11$ G for $(\text{CH}_3)_2\dot{\text{C}}\text{H}$. The more nearly equal couplings for the latter comparison apparently result from a somewhat diminished spin density on nitrogen in $(\text{CH}_3)_2\dot{\text{N}}\text{H}^+$ as compared

to the central carbon in $(\text{CH}_3)_2\dot{\text{C}}\text{H}$ as a result of more effective hyperconjugation in the aminium radical (vide infra). The a_{NH}^H and a_{α}^H couplings are negative, of course, with the hfc in the nitrogen-centered radicals enhanced by an excess charge effect by which the effective radius of the hydrogen 1s atomic orbital is influenced by its excess charge; the hfc is proportional to Z^3 for hydrogen.¹⁸⁰ This effect is particularly obvious when the series $\cdot\text{BH}_3^-$, CH₃[•], and NH₃⁺ is examined: $a^H = -16.5$; -23 , and -25.9 G, respectively.

The hfs interaction of hydrogens β to the site of unpaired electron density in a planar π radical arises principally by a hyperconjugative mechanism and follows a relationship $a_{\beta}^H = (A + B \cos^2 \theta)\rho$ ¹⁸¹ in which θ is the angle between the axis of the 2p orbital at the central atom and the plane containing the central atom, C _{β} , and H _{β} ; ρ is the spin density at the central atom. Since A is generally much smaller than B , the expression may be shortened to $a_{\beta}^H = Q_{\text{CCH}}^H \rho$ when considering a rapidly rotating methyl substituent ($\cos^2 \theta = 0.5$). For the series CH₃ $\dot{\text{C}}\text{H}_2$, $(\text{CH}_3)_2\dot{\text{C}}\text{H}$, and $(\text{CH}_3)_3\dot{\text{C}}$, Fessenden and Schuler¹⁸² have demonstrated that Q_{CCH}^H is constant at 29.3 G assuming that the spin density at the central carbon followed the expression $\rho_c = (1 - 0.081)^m$, where m is the number of methyl groups attached to the central carbon. This Q value derived from the neutral alkyl radicals is not universally applicable, however, and systematic deviations have been observed with aromatic alternate hydrocarbon radical anions and cations. In general, cation splittings are larger than those expected from an equivalent spin density in the anion which suggests that the Q value is somewhat dependent upon the charge at the central atom.^{183,184} Hyperconjugation to a β hydrogen is apparently more effective in a positively charged radical because of a better matching of the energies of the 2p orbital possessing the unpaired spin and the appropriate C-H orbital.

A Q_{NCH}^H value of 32.7 G was determined for neutral dialkylamino radicals from the observed methyl coupling of 27.36 G and an INDO geometry-optimized nitrogen 2p spin density for $(\text{CH}_3)_2\dot{\text{N}}$.¹⁷¹ A similar analysis for the aminium radical $(\text{CH}_3)_2\dot{\text{N}}\text{H}^+$ suggested $Q_{\text{NCH}}^H = 42.9$ G reflecting the enhanced hyperconjugative effect in the charged radical. The INDO calculated spin densities of 0.8370 and 0.7996 for the neutral and charged nitrogen-centered radicals¹⁷¹ may be compared with an estimated ρ_c of 0.844 for $(\text{CH}_3)_2\dot{\text{C}}\text{H}$.¹⁸² These estimates illustrate more effective spin delocalization for the charged radical than for the isoelectronic alkyl radical.

Enhanced long-range, through-bond couplings to remote γ and δ hydrogens are obvious in **22**⁺ and **23**⁺. These hydrogens are well aligned to form a planar zigzag chain (W plan),¹⁸⁵ and the lower energy of the positively charged nitrogen orbital (relative to carbon in the corresponding alkyl radicals¹⁵⁷) allows a better mixing with the appropriate C-C bonds. The δ couplings of 14.3 and 10.8 G in **22**⁺ and **23**⁺, respectively, and the γ interaction of 7.02 G in **23**⁺ are the largest couplings of these types known to the present authors.

Variations in a_{β}^H for $(\text{CH}_3)_2\dot{\text{N}}\text{H}^+$ (34.27 G), $(\text{CH}_3\text{CH}_2)_2\dot{\text{N}}\text{H}^+$ (37.19 G), and $[(\text{CH}_3)_2\text{CH}]_2\dot{\text{N}}\text{H}^+$ (21.7 G) demonstrate that there is restricted rotation about the C-N bonds in the latter two radicals.¹⁷¹ Comparison with the corresponding dialkylamino radicals indicated a less pronounced conformational preference in the charged radicals, however, which was accounted for by a more opened CNC angle for the aminium radicals (INDO calculated 126° for $(\text{CH}_3)_2\dot{\text{N}}\text{H}^+$) as opposed to the neutral species (117° for $(\text{CH}_3)_2\dot{\text{N}}$).

c. Theoretical Calculations

Nonaromatic aminium radicals, particularly NH₃⁺, have been subjected to a number of theoretical treatments by both semi-empirical and ab initio methods. Cole,^{3a} using Hartree wave functions, calculated $a^N = 21.4$ – 23.2 G and 157.4 G for planar

and tetrahedral (H-N-H angles = 109.5°) NH_3^+ , respectively. By comparison with his observed a^{N} values of 19.5 (NH_3^+) and 18.8 G (ND_3^+), he concluded that these radicals must be planar and that the smaller value for the deuterio compound resulted from a lowered amplitude of the umbrella mode vibrations.

Giacometti and Nordio,¹⁶³ using SCF molecular orbitals obtained from Hartree-Fock-type atomic orbitals and performing an extensive configuration interaction calculation, obtained $a^{\text{N}} = 20.9$ and $a^{\text{H}} = 28.8$ G for planar NH_3^+ and $a^{\text{N}} = 66$ G for a pyramidal configuration. These calculations were likewise taken as justification for a planar or quasi-planar NH_3^+ .

A more rigorous calculation utilizing an ab initio UHF method in the LCAO-MO approximation involving spin annihilation of the quartet spin state and optimization of the N-H bond length and hydrogen atom orbital exponent yielded $a^{\text{N}} = 10.57$ G and $a^{\text{H}} = -22.65$ G for NH_3^+ .¹⁸⁶ It was further calculated that inclusion of the out-of-plane zero-point energy vibration increased a^{N} to 16.92 G and a^{H} to -20.02 G indicating the importance of vibronic effects to a^{N} .

Pople and co-workers,^{187a} utilizing ab initio methods with both minimal (STO-3G) and extended (4-31G) basis sets, obtain a planar geometry with D_{3h} symmetry for NH_3^+ . Interestingly, the former basis set gives a slightly nonplanar configuration for $\cdot\text{CH}_3$.

In an analysis of localized molecular orbitals generated from INDO wave functions for various amino radicals, vibronic contributions to a^{N} for $\cdot\text{NH}_2$ and NH_3^+ were examined.¹⁶⁵ The energy-minimum a^{N} value for NH_3^+ of 21.6 G was found to be somewhat larger than that from ab initio methods and the vibronic contribution of +1.6 G to be considerably smaller. The energy localized α spin orbitals of NH_3^+ were found to make angles of 112° with the threefold spin axis and were surprisingly similar to those of NH_3 even though a planar geometry was calculated for the radical. It was concluded that this situation leads to about 6% direct delocalization of the lone orbital over the three hydrogen NH_3^+ orbitals.

The INDO method also suggested that a^{N} in aminium radicals is not overly sensitive to out-of-plane deformations.¹⁶¹ For example, a^{N} is calculated as 21.5 G (3.9%) and 44.9 G (8.2%) for planar and tetrahedral NH_3^+ , respectively, while $a^{13\text{C}} = 46.8$ G (4.2%) and 139.5 G (12.6%) for the isoelectronic $\cdot\text{CH}_3$ radical. Similar effects are noted in a^{N} for NF_3^+ [18.1 G (3.3%) planar and 55.3 G (10.1%) tetrahedral] and $\cdot\text{CF}_3$ [38.7 G (3.5%) planar and 222.6 G (20.1%) tetrahedral]. The percentages are in reference to the maximum couplings possible, 550 G for ^{14}N and 1110 G for ^{13}C .¹⁵¹ It has been shown that INDO calculated $a^{13\text{C}}$ values are in quite good agreement with the experimental values for **10**, **11**, and **14**. Although not in quantitative agreement, INDO does predict relatively small a^{N} values for **21-23** as is observed. It appears plausible, therefore, that distorting a charged aminium radical from a planar geometry may not be as effective in admixing real 2s character into the orbital of the unpaired electron as is a similar distortion in an alkyl radical.

As noted above, INDO calculates a larger CNC angle for $(\text{CH}_3)_2\text{NH}^+$ than for the conjugate base, $(\text{CH}_3)_2\text{N}^-$, which can account for the diminished conformational preference for the alkyl substituents in R_2NH^+ .¹⁷¹ The calculated hfsc's, $a^{\text{N}} = 16.7$, $a_{\text{NH}}^{\text{H}} = -25.2$, and $a_{\text{CH}_3}^{\text{H}} = 28.7$ G for $(\text{CH}_3)_2\text{NH}^+$ are in reasonable agreement with experiment (Table I).

2. Electronic Spectra

Whereas there are considerable data on the electronic spectra of transient neutral amino radicals and highly conjugated, stable aminium radicals (Wurster's salts, Weltz's salts, etc.), there are but few reports of such spectra for nonaromatic aminium radicals. Flash photolysis of *N*-nitrosopiperidine in 0.01 M HCl produced a transient with a maximum <280 nm which was attributed to the piperidinium radical.^{99,100} The radical had a life-

time of $124 \pm 10 \mu\text{s}$ under these conditions. A similar absorption spectrum was obtained from the flash photolysis of *N*-chloropiperidine in 0.01 M H_2SO_4 .^{99,100}

Utilizing a pulse radiolysis technique to generate hydroxyl radicals, Simic and Hayon observed the absorption spectrum of HONH at λ_{max} 217 nm, but in more acidic solution in which HONH_2^+ would exist only a weak absorption with a maximum <220 nm was reported.¹⁰² In contrast, an isoelectronically related species, the hydrazine radical cation 9,9'-bis(9-azabicyclo[3.3.1]nonane) hexafluorophosphate has λ_{max} 345 nm and $\log \epsilon = 3.56$ in 95% ethanol.^{187b} No transients that could be assigned to the $\cdot\text{NH}_2$ or $\cdot\text{NH}_3^+$ radical were observed on pulse radiolysis of oxygen-free NH_2OH at pH 7.0 or 3.0. The existence of the latter species was demonstrated, however, by observing the absorption spectrum of its adduct to benzene.

The hypochlorous acid oxidation of Dabco in a flow system utilizing acetonitrile-H₂O solvent produced the reddish radical cation which had λ_{max} 465 nm (ϵ 2104 \pm 231 M⁻¹ cm⁻¹) in the visible region reflecting the delocalized nature of the unpaired electron.⁵¹ The color of the transient intermediate was not invariant. In pure acetonitrile it was green, but in acetonitrile containing sodium perchlorate it was reddish brown.³⁹

The aminium radical **24**⁺ is also reddish brown in acetonitrile (λ_{max} 480 nm ($\log \epsilon_{\text{max}}$ 3.1)).¹³⁴ The similarity in λ_{max} for Dabco⁺ and **24**⁺ must be considered fortuitous since the two radical cations possess fundamentally different bonding. The former radical is delocalized via a through-bond mechanism while the latter has a direct through-space interaction of the two nitrogens with the electronic excitation involving the $n_+ \rightarrow n_-$ transition.¹³⁴

It has been observed¹¹⁵ that solutions containing **25**⁺ were intensely purple (λ_{max} 564 nm) which reflects a lower energy electronic transition than either **24**⁺ or Dabco⁺. Likewise, oxidation of solutions of *N,N'*-dimethyl-1,5-diazacyclooctane produced a transient red color which was ascribed to the aminium radical.³⁰ However, this interpretation might be questioned since one of the present authors¹⁸⁸ has determined the lifetime of this aminium radical to be less than 5 ms in neutral acetonitrile.

There is obviously a paucity of data on the electronic spectra of nonaromatic aminium radicals and additional work in this area would be desirable.

B. Experimental Redox Energetics

1. Electrochemical Measurements

Whereas ESR data contribute to an understanding of the electronic structure and spin distribution in nonaromatic aminium radicals, electrochemistry can yield information on the ease of formation and stability of these transient intermediates. To quantitate the ease of formation of aminium radicals in solution, the E° values for amine \rightarrow (amine)⁺ + e⁻ redox couples are required. Such data have been acquired in only a few cases. The most common method to obtain E° experimentally is to use cyclic voltammetry,¹¹² in which current is observed as a function of potential when a triangular potential vs. time wave is applied to the working electrode. If the electron transfer is electrochemically reversible (fast compared to the potential scan rate), an oxidation wave is observed as the potential is increased past E° for the redox couple, and on the return scan, a reduction wave of the same height as the oxidative wave is observed. In the absence of experimental and kinetic problems, the difference in peak potential for the two waves is 56 mV for a one-electron transfer, and E° for the couple is equal to $E_{1/2}$, the average of the peak potentials (E_p) for the oxidation and reduction waves. If the electron transfer is electrochemically irreversible (slow compared to the scan rate), the oxidation potential is shifted anodically (to more positive values) from the "reversible" po-

TABLE II. Peak Potentials for Some Acyclic Alkylamines

Compound	E_p (V vs. $Ag^+ AgNO_3, CH_3CN, Pt$ electrode ¹¹⁷)	E_p (V vs. SCE) aqueous, C electrode
Me ₂ NH		1.03 ^a
Et ₂ NH	1.01	1.00 ^a
<i>n</i> -Pr ₂ NH	0.92	0.90 ^a
<i>n</i> -Bu ₂ NH	0.87	
<i>n</i> -Pent ₂ NH	0.86	
<i>i</i> -Pr ₂ NH	1.00	
(C ₆ H ₅) ₂ NH	1.08	
Me ₃ N	0.82	0.76 ^a
Et ₃ N	0.66 ^c	0.69 ^{a, d}
<i>n</i> -Pr ₃ N	0.64	
<i>n</i> -Bu ₃ N	0.62	
<i>n</i> -Pent ₃ N	0.55	
<i>n</i> -Bu ₂ NMe		0.65 ^b
<i>i</i> -PrNMe ₂		0.73 ^b
4-MeC ₆ H ₄ CH ₂ NMe ₂		0.76 ^b
C ₆ H ₅ CH ₂ NMe ₂	0.71	0.77 ^b
4-ClC ₆ H ₄ CH ₂ NMe ₂	0.73	0.78 ^b
4-Cl ₃ CC ₆ H ₄ CH ₂ NMe ₂		0.80 ^b
4-CNC ₆ H ₄ CH ₂ NMe ₂	0.82	0.81 ^b





^a At pH 11.9, ^b in 30% methanol containing 10⁻³ M NaOH, ^c A value corresponding to 0.79 was obtained by Miller and co-workers¹²⁰ under similar conditions. ^d A value of 0.73 was obtained by Lindsay Smith's group.¹¹⁹

sition of 56/2 mV anodic of E° , the amount depending upon the heterogeneous rate constant for electron transfer. If the radical cation is so reactive that it is destroyed before reduction on the negative-going scan, no cathodic wave is observed, and E_p^{ox} shifts cathodically, the amount depending upon the rate of the following reaction.^{113, 114}

The radical cations from simple aliphatic amines are so reactive that only an oxidation wave is observed by cyclic voltammetry, the only exception yet reported being 9-*tert*-butyl-9-azabicyclo[3.3.1]nonane (**26**) which gives a completely reversible CV wave.¹³³ It is possible that the shifts of E_p from E° would be similar for all aliphatic amines (which would occur if the reactions destroying the cations were, e.g., all diffusion controlled), so that differences in E_p would reflect differences in E° . Mann¹¹⁶ reported the first cyclic voltammetry studies on amines, and the latest set of values from his group appears in a monograph by Mann and Barnes.¹¹⁷ Monoalkylamines show only extremely distended waves, and the E_p values observed (+1.63 to 1.72 V) do not respond to changes in alkyl group substitution in a reasonable way; these values are probably useless for predicting true E° differences. In contrast, E_p values for secondary and tertiary amines respond to alkyl group changes in a regular manner. Mann's data were obtained at a platinum electrode in acetonitrile while Masui and co-workers¹¹⁸ have reported similar data in aqueous solution at a glassy carbon electrode. A comparison of some of the E_p values obtained by these two groups appears in Table II, along with data for arylmethyl dimethylamines, from the work of Lindsay Smith¹¹⁹ and Mann.¹¹⁷ The observed decrease in E° with homologation of alkyl groups and the slight increase as electron-withdrawing groups are substituted on an arylmethyl group reinforce the hope that the E_p values measured represent changes in E° .

Values of E_p for a number of tertiary alkylamines have recently been reported by Lindsay Smith and Masheder,¹¹⁹ some of which are summarized in Table III. The pattern of E_p values observed for the monocyclic compounds was interpreted as reflecting a late transition state for electron transfer, because the dependence upon ring size resembles that seen in solvolysis rates of alkyl chlorides and thermolysis rates of azocycloalkyl nitriles.¹¹⁹ The high E_p of quinuclidine, **22**, reflects ring strain in the radical cation, while the low E_p for 1-azamanxane, **27**, results from relief

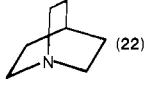
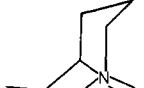
TABLE III. Peak Potentials for Some Cyclic Alkylamines

Compound	E_p (V vs. SCE) ^a
N- <i>n</i> -Bu ₃	1.63
(CH ₂) ₄ NMe	0.68
(CH ₂) ₅ NMe	0.80
(CH ₂) ₆ NMe	0.60
(CH ₂) ₇ NMe	0.51
	0.77
	0.74
	0.63
	0.96 ^b
	0.38
	0.74 ^c (E°)
	0.82 ^c

^a MeOH, 10⁻³ M NaOH, C electrode: reference 119. ^b A value of 1.10 V vs. SCE at a gold electrode in acetonitrile has been reported.¹²⁶ ^c In CH₃CN.¹³³

of strain in going to the cation; **27** is known to be nearly flat at nitrogen in the neutral form¹²¹ as a result of the bicyclo[3.3.3]-undecyl framework.

A reliable E° value may be obtained electrochemically when the cation radical is sufficiently long-lived for a reduction wave to be observed in the cyclic voltammogram since E° must lie between the peak potentials. The radical cations of amines conjugated with double bonds are frequently sufficiently stable for determination of E° , as Fritsch, Weingarten, and Wilson have shown;¹²² E° values are given in Table IV. The radical cation lifetime increases markedly as dimethylamino groups are substituted on a double bond, and E° decreases dramatically. As Kuwata and Geske¹²³ first showed, tetrakis(dimethylamino)-ethylene (**28**) is astonishingly easily oxidized since even the second electron can be removed at a potential which will reduce nitrobenzene to its radical anion. In air, **28** oxidizes in a complex acid-catalyzed, chemiluminescent reaction.^{124, 125} For tetrakis(dimethylamino)-2,3-dimethylbutadiene (**29**), removal of the second electron is actually more facile than removal of the first, an effect which must be caused by the strain present in the planar radical cation. The dication can rotate about the C₂-C₃ bond to reduce steric interactions considerably compared to the monocation which has a high π bond order between C₂ and C₃. A single, two-electron oxidation wave is observed by cyclic voltammetry, and ΔE° was measured by determination of the neutral-dication disproportionation constant.¹²²

The study of the oxidation of saturated diamines received its impetus from Geske's discovery that Dabco has a remarkably long-lived radical cation.¹²⁷ Some peak potentials which have been reported for diamines¹²⁶ appear in Table V. It is clear that there is a sharp increase in E_p in going from a 1,4- to a 1,3-diamine, as expected on inductive grounds because an NCH₂

TABLE IV. Oxidation Potentials and Lifetimes for Some Dimethylamino-Substituted Olefins¹²²

Compound	E°_1 ^a	E°_2 ^b	$t_{1/2}$, s ^c
	+0.42 ^d		$<5 \times 10^{-3}$
	+0.38		3×10^{-3}
$(\text{Me}_2\text{N})\text{C}=\text{CMe}_2$	+0.25		25×10^{-3}
	+0.24		Days
$(\text{Me}_2\text{N})_2\text{C}=\text{CCl}_2$	+0.52		250
$(\text{Me}_2\text{N})_2\text{C}=\text{CHNMe}_2$	-0.40	-0.17	Days
$(\text{Me}_2\text{N})_2\text{C}=\text{C}(\text{NMe}_2)_2$ (28)	-0.77	-0.65	Days
$(\text{Me}_2\text{N})_2\text{C}=\text{CH}^-$	-0.40	-0.17	Days
$(\text{Me}_2\text{N})_2\text{C}=\text{CMe}^-$ (29)	-0.90	-1.02	Days

^a For removal of one electron. ^b For removal of a second electron.

^c Lifetime of the radical cation, determined by cyclic voltammetry or ESR.
^d Irreversible wave; value given is at 25% of the peak current, 100 mV/s scan rate.

substituent is electron withdrawing compared to a CCH_2 substituent. The lifetimes of the radical cations from the diamines in Table V (except for Dabco and **25**) are short on the cyclic voltammetry time scale, and the E_p values observed provide no support for a contention that the nitrogens are sharing the positive charge.

In contrast, Dabco gives a far longer lived cation, allowing measurement of E° .^{126,127} The ESR spectrum of Dabco^+ showed two equivalent nitrogens (Table I),^{127,128} and a special interaction between the nitrogens was suggested even in the neutral molecule by its long-wavelength absorption maximum.¹²⁷ Hoffmann and others¹²⁹ pointed out that two types of intramolecular orbital-orbital interactions could lead to special effects in Dabco. The nitrogen lone-pair orbitals could interact through-space by back-lobe overlap, or there could be a through-bond interaction. For the latter, the symmetric C-C σ bond orbital combination, which is geometrically ideally situated for the purpose, mixes with the symmetric lone-pair orbital combination. Extended Hückel calculations predicted that the through-bond interaction was substantially larger than the through-space one. These conclusions were strikingly confirmed by the photoelectron spectroscopy work of Heilbronner and co-workers.¹³⁰ The nitrogens of Dabco are thus "conjugated" with each other through the σ bonds, as a result of the special geometry of this system. Staley and Beauchamp¹³¹ have measured the $\text{R}_3\text{N}^+-\text{H}$ bond dissociation energy for protonated **22** and Dabco to be 97.4 and 83.3 kcal/mol, respectively, by ion cyclotron resonance techniques, and assigned the 14-kcal/mol difference as the resonance stabilization energy of Dabco.

The probability of three-electron σ bonding in $\mathbf{24}^+$ and $\mathbf{25}^+$ is discussed above and presumably leads to their otherwise surprisingly low oxidation potentials.

2. Ionization Potentials

The vapor-phase ionization potential¹³⁶ gives the energy required for removal of an electron from a compound. Formally, ionization potentials are similar to E° values, which are not available for most the compounds of interest here. Unfortunately for this purpose, the "lone-pair" electrons on an amino nitrogen are advisedly written in quotation marks, because these orbitals are actually significantly admixed with other orbitals in the molecule. There is a large geometry change when an electron is removed from an alkylamine, which is approximately tetra-

TABLE V. Peak Potentials for Some Saturated Diamines

Compound	E_p (V vs. SCE) ^a
$\text{Me}_2\text{NCH}_2\text{NMe}_2$	0.87
$\text{Me}_2\text{NCH}_2\text{CH}_2\text{NMe}_2$	0.66
	0.75
	0.60 ^b
	0.56
	1.20
	0.84
	0.69
	1.37
	0.58 ^c
	0.11 ^d

^a At gold, in acetonitrile; ref 126. ^b Partially reversible at room temperature, $E^{\circ} = 0.57$ ¹²⁶ (compare with 0.68 reported by McKinney and Geske¹²⁷). ^c Partially reversible at room temperature, $E^{\circ} = 0.56$.¹²⁶ ^d E° value; reversible at all temperatures.¹³⁴

hedral at nitrogen, to give an amine radical cation, which is planar. For this reason there is a substantial difference between the adiabatic ionization potential (I_a , the energy required to remove an electron from a neutral amine in its zeroth vibrational level to give a vibrationally relaxed radical cation) and the vertical ionization potential (the "vertical" energy gap to an ion having the same geometry as the neutral amine). There must be a great mismatch of vibrational states between a neutral and an ionized amine. It is the adiabatic ionization potential, I_a , which corresponds to the electrochemical E° (except for the phase difference).

Experimental measurement of I_a for most amines is plagued by the vibrational mismatch problem, resulting in vanishingly small intensities at the onset of ionization. Where special circumstances result in vibrational fine structure being observed in the lone-pair ionization band by photoelectron spectroscopy (PES),¹³⁷ as it is for ammonia¹³⁷ and certain bicyclic amines and diamines (including Dabco, **22**, **25**, **30**, and **31**), the first observed fine-structure maximum¹³⁰ is at least close to I_a , although it is not always clear that the 0,0 band has actually been observed. For the bicyclo[3.3.3]undecane derivatives **24**¹³⁷ and **27**¹³⁸ in which the nitrogens are nearly planar in the neutral form and only

TABLE VI. Representative Amine Adiabatic Ionization Potentials¹⁴²

Compound	I_a , eV ^a	Compound	I_a , eV ^a
NH ₃	10.154	Et ₂ NH	7.85
MeNH ₂	8.89	<i>n</i> -Pr ₂ NH	7.76
EtNH ₂	8.76	<i>i</i> -Pr ₂ NH	7.59
<i>n</i> -PrNH ₂	8.54	Me ₃ N	7.76
<i>i</i> -PrNH ₂	8.63	Et ₃ N	7.11
Me ₂ NH	8.15	<i>n</i> -Pr ₃ N	7.03

^a Precision quoted at 0.1 eV.¹⁴²

minor geometrical changes occur upon ionization, very strong 0,0 bands are observed, and I_a is unambiguously determined. The situation is quite different for most aliphatic amines, for which the lone-pair ionization band is a featureless lump, with a gradual onset. Although in early PES work "adiabatic" first-rise I_a values were reported for several amines,¹³⁹ the photoionization technique developed by Watanabe gave distinctly lower, and hence preferable, I_a values for amines¹⁴⁰ (for eight compounds in common, the PES values were an average of 0.25, range 0.08–0.50 eV higher than the photoionization values). Even the early PES I_a values of 8.70^{139a} or 8.73^{139b} eV are clearly to be preferred over photoionization values for benzylamine. Now that the baseline problem¹³⁹ of early PES instruments has been solved, it is common to only report PES peak maxima, I_v , since these values are more precisely measured. Since PES I_v values for many acyclic, cyclic, and bicyclic amines^{141,142} and diamines^{132,143,144} have been reported, there has been an understandable reluctance to quote first-rise PES values as I_a .¹⁴⁵ Aue and co-workers¹⁴² have recently published such a set of data, part of which appears in Table VI. Their PES I_a values are uniformly lower than Watanabe and Mottl's photoionization I_a values¹⁴⁰ (average 0.14, range 0.04–0.39 eV for 11 compounds in common), and are therefore presumably to be preferred. It is not now apparent how much a tenfold increase in signal-to-noise ratio would alter the position of first-rise for the PES peak of these amines; we note that PES derived I_a values decreased an average of 0.41 eV between 1964^{139a} and 1976,¹⁴² presumably due to improvements in instrumentation.

3. Data Correlations

a. Oxidation Potentials

Since I_a is the energy gap between the neutral species and the radical cation in the vapor phase, and E° is the corresponding energy gap in solution (reported in the same unit, eV, although it is measured vs. an arbitrary standard, the potential of the reference electrode employed), there is obviously a relationship between the quantities. Because solution energies are different for neutral species and ions, a quantitative interrelation of the two would require much more knowledge of solution energies than is presently available. Nevertheless, the relationship between I_a and E° has been investigated, most ambitiously by Miller and co-workers.¹²⁰ A plot of ionization potentials against halfwave potentials yielded a linear correlation, $E_{1/2} = 0.92$ (IP)–6.20 V, $r = 0.92$. One of the present authors (S.F.N.) attempted a more extensive correlation and plotted Watanabe's I_a values (Table VI) vs. Mann's E_p values (Table II) which yielded $E_p = 0.38I_a - 2.11$, $r = 0.87$, in poor agreement with Miller's correlation for other compounds. Lack of agreement is to be expected for attempting to utilize kinetically influenced E_p values to measure thermodynamically significant E° values. It seems likely that kinetic shifts and differential solvation effects affect the E_p values significantly.

Straight lines were observed in correlations of aliphatic amine E_p values with Taft's inductive parameter σ^* both in acetonitrile ($E_p = 0.78 + \Sigma\sigma^*$)³⁸ and in water.¹¹⁸ Arylmethyl dimethylamine E_p values were observed to correlate with Hammett σ param-

eters^{38,119} ($\rho = -0.94$)¹¹⁹ and the pK_a of the amine^{38,119} ($r = 0.82$).¹¹⁹

b. Rates of Oxidation

Studies of alkylamine oxidation rates have been carried out principally by Rosenblatt's group using chlorine dioxide in water or acetonitrile^{34–40} and other oxidants^{32,33} and by that of Lindsay Smith, using potassium ferricyanide in basic 30% methanol^{26,29,30} (see section IV). The observed rate constants have been found to correlate with the pK_a of the amines, σ (for arylmethyl dimethylamines), σ^* ,^{26b} I_a , and E° of the oxidizing agent.³² For arylmethyl- and triarylmethylamine reactions with ferricyanide, $\rho = -0.99$, $r = 0.99$;^{26b} with chlorine dioxide, $\rho = -0.92$, $r = 0.81$.³⁵ These ρ values are similar to the corresponding correlations of E_p in anodic oxidations^{38,119} implying electron transfer in the rate-controlling step. This conclusion is supported by isotope effect studies, where k_H/k_D is only 1.04 for CD₃N-*n*-Bu₂²⁹ (see ref 119 for similar studies). Brønsted plots for aliphatic amine oxidation tend to separate into different lines for primary, secondary, and tertiary amines.³⁸

Hydrogen abstraction has been shown³⁶ to compete with electron transfer as the rate-controlling step for chlorine dioxide oxidation of benzylamine derivatives, being more important for benzylamine (73% H abstraction) than for dibenzylamine (35%), and unimportant in tertiary amines. A late transition state for the electron-transfer reaction with trialkylamines, in which considerable flattening at nitrogen has occurred, is inferred from the relative rates of cyclic and bicyclic amines.²⁹ Systematic studies of the rate decrease associated with introduction of a second nitrogen or oxygen function in the molecule have recently appeared.³⁰ Beileryan and co-workers have correlated aliphatic amine oxidations by potassium persulfate,¹⁴⁶ benzoyl peroxide,^{146,147} and dicyclohexyl peroxydicarbonate¹⁴⁸ with ionization potentials although only abstracts of these works were available to the present authors.



4. Factors Contributing to Aminium Radical Lifetimes

Even tertiary amine radical cations ($A^{\cdot+}$) are only short-lived intermediates in amine oxidations, because deprotonation at the α -carbon leads to α -aminoalkyl radicals (B^\cdot) (eq 12). Because B^\cdot is expected to be far more easily oxidized than the parent amine (E°_B is negative of E°_A ; although no E°_B values are known, the difference is well over 0.7 V in the isoelectronic trialkylhydrazine, trialkylhydrazyl comparison⁴⁶), formation of B^\cdot under conditions which oxidize A leads to very rapid conversion to B^+ .

The lifetime of $A^{\cdot+}$ is thus expected to be principally controlled by its rate of deprotonation. Although $A^{\cdot+}$ has an appreciable lifetime in strongly acidic solution, under the conditions of cyclic voltammetry experiments, simple trialkylamine cations do not exist for even the few milliseconds required for observation of a reduction wave in the reverse sweep. When the charge density at nitrogen is decreased by delocalization and there are at least two nitrogens to share the charge, lifetimes become appreciable, as seen in Table IV.

Because B^\cdot has a three-electron π bond,¹⁴⁹ twisting about the R₂N–CR'₂ bond should be difficult, leading to a Bredt's rule type of destabilization in bicyclic systems, and presumably a decreased rate of deprotonation as a consequence. It appears that this effect has importance in determining the lifetime of Dabco⁺, because the next higher homologue, 1,5-diazabicyclo[3.2.2]nonane, $30^{\cdot+}$, which has nearly two-thirds of the through-bond interaction of Dabco⁺,¹⁴⁴ and a comparable E_p (Table V), shows no trace of a reduction wave in its cyclic voltammogram, even at low temperature.¹⁵⁰ Rosenblatt and co-workers have shown that Dabco⁺ decomposes by C–C bond cleavage instead of deprotonation.^{37,52} The tetraamine $25^{\cdot+}$ also appears to decompose by C–C cleavage, because deuteration of all of the

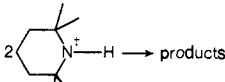
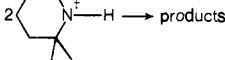
TABLE VII. Absolute Rate Constants for Aminium Radical Reactions

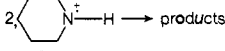
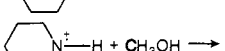
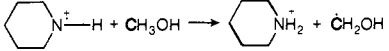
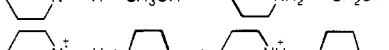
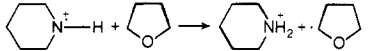
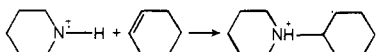
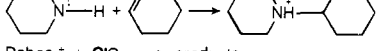
	Rate Constant	Solvent	Ref
$2(\text{CH}_3)_2\text{NH}^{\cdot+} \rightarrow \text{products}$	$5.3 \times 10^6 \text{ M}^{-1} \text{ s}^{-1}$	1.24 M $\text{H}_2\text{SO}_4/\text{HOAc}$	190
	$4.0 \times 10^5 \text{ M}^{-1} \text{ s}^{-1}$	5.0 M $\text{H}_2\text{SO}_4/\text{CF}_3\text{CO}_2\text{H}$	190
	$2.1 \times 10^4 \text{ M}^{-1} \text{ s}^{-1}$	1.3 M $\text{H}_2\text{SO}_4/\text{HOAc}$	190
	$1.7 \times 10^3 \text{ M}^{-1} \text{ s}^{-1}$	3.0 M $\text{H}_2\text{SO}_4/\text{CF}_3\text{CO}_2\text{H}$	190
	$\sim 7.7 \times 10^4 \text{ M}^{-1} \text{ s}^{-1} \text{ }^a$	H_2O , pH 2	100
	$8.06 \times 10^3 \text{ M}^{-1} \text{ s}^{-1} \text{ }^b$	H_2O , pH 2	100
	$2.6 \times 10^3 \text{ M}^{-1} \text{ s}^{-1} \text{ }^a$	H_2O	100
	$2.4 \times 10^3 \text{ M}^{-1} \text{ s}^{-1} \text{ }^b$	H_2O	100
	$5 \times 10^4 \text{ M}^{-1} \text{ s}^{-1}$	H_2O	100
	$2.0 \times 10^7 \text{ M}^{-1} \text{ s}^{-1} \text{ }^a$	H_2O	100
	$2.4 \times 10^7 \text{ M}^{-1} \text{ s}^{-1} \text{ }^b$	H_2O	100
$\text{Dabco}^{\cdot+} + \text{ClO}_2 \rightarrow \text{products}$	$1.31 \times 10^4 \text{ M}^{-1} \text{ s}^{-1}$	H_2O	40

^a Radicals generated from corresponding chloramine. ^b Radicals generated from corresponding nitrosoamine.

NCH_2N positions does not increase the lifetime of the dication, and an easily detectable primary isotope effect would be expected if deprotonation were the slow step in the decomposition. Species $24^{\cdot+}$ does not deprotonate rapidly even under slightly basic conditions, but has a distinctly longer lifetime at a pH of 2.¹³⁴ Elimination of overlap between the spin-bearing orbital on nitrogen and the $\text{C}_\alpha\text{-H}$ bonds by making the latter bridgehead as in a bicyclo[3.3.1]nonyl system makes even a monoamine radical cation persistent; **26** (Table III) has a lifetime of over 2 h at room temperature, but **32**, which possesses a $\text{C}_\alpha\text{-H}$ bond which can overlap, has a lifetime under 10 ms at -60°C .¹³³

IV. Chemical Reactions Involving Nonaromatic Aminium Radicals

A. Acid-Base Reactions

Except for electron transfer, the gain or loss of a proton is the most fundamental bimolecular reaction that a compound can undergo. Aminium radicals are the conjugate acids of neutral amino radicals and the acidities of several aminium radicals have been measured. Fessenden and Neta¹⁰³ have determined the $\text{p}K_a$ of $(\text{CH}_3)_2\text{NH}^{\cdot+}$ as 7.0 ± 0.5 (eq 25) which compares with a

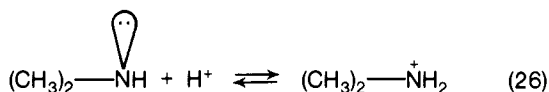
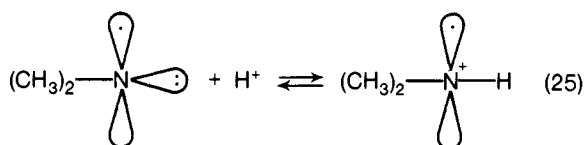

value of 10.7 for $(\text{CH}_3)_2\text{NH}_2^{\cdot+}$ (eq 26). Ignoring effects of solvation differences, the greater acidity of the aminium radical can be attributed to the greater amount of s character in the lone-pair orbital of $(\text{CH}_3)_2\text{N}^{\cdot+}$ (approximately sp^2 hybridized) as compared to the more basic lone pair orbital in $(\text{CH}_3)_2\text{NH}$ (approximately sp^3 hybridized). The $\text{p}K_a$ s for $\text{NH}_3^{\cdot+}$ (6.7 ± 0.2 vs. 9.24 for NH_4^+), $\text{HONH}_2^{\cdot+}$ (4.2 ± 0.1 vs. 6.1 for HONH_3^+), and $\text{CH}_3\text{ONH}_2^{\cdot+}$ (2.9 ± 0.2 vs. 4.6 for $\text{CH}_3\text{ONH}_2^+$) exhibit similar effects.¹⁰²

In contrast, the $\text{p}K_a$ of 7.0 observed¹⁸⁹ for the anilinium radical, $\text{C}_6\text{H}_5\text{NH}_2^{\cdot+}$ is considerably higher than the $\text{p}K_a$ of 4.6 for protonated aniline, $\text{C}_6\text{H}_5\text{NH}_3^+$. The basicity of the anilinium radical is seen to be very comparable to that of $(\text{CH}_3)_2\text{NH}^{\cdot+}$ reflecting the approximately sp^2 hybrid character of the N-H bonds in both species. The low basicity of aniline results from the delocalization of the lone-pair electrons and the loss in resonance stabilization upon protonation.

B. Kinetic Behavior

As is the case for many transient intermediates, there are relatively few absolute rate constants reported for nonaromatic aminium radicals. In order to unambiguously observe the kinetics of aminium radical reactions these radicals should be generated in a non-steady-state by flash photolysis or pulsed kinetic ESR spectroscopy. Available rate constants for the self-reaction, hydrogen abstraction, and addition reactions of nonaromatic aminium radicals are summarized in Table VII.

Malatesta and Ingold have studied chloramine photolysis by kinetic ESR spectroscopy¹⁹⁰ and have shown that dimethylaminium and 2,2,6,6-tetramethylpiperidinium radicals generated in highly acidic media, e.g., 1–6 M H_2SO_4 in AcOH or trifluoroacetic acid, exhibit clean second-order decay kinetics; the bimolecular rate constants decrease with increasing solvent acidity and can be linearly correlated with H_0 (Hammett acidity scale) but are independent of solvent viscosity. Conceivably the reaction mechanism of aminium radicals changes in a high acidity region. The bimolecular decay of aminium radicals, however, poses some problem for a mechanistic interpretation and points to the need of further work. Regardless of mechanistic interpretation, aminium radical reactivity is slightly reduced at higher acidity, e.g., $(\text{CH}_3)_2\text{NH}^{\cdot+}$ decay rate constants decrease from 10^6 to $10^5 \text{ M}^{-1} \text{ s}^{-1}$ during H_0 changes from -3 to -9 . Variation of aminium radical reactivity as a function of the acidity of media has been suggested in the chlorine dioxide dealkylation of trialkylamines⁵¹ and also can be gleaned from the studies of metal ion catalyzed decomposition of amine oxides (eq 27),^{62,191} in low acid or neutral media rapid loss of an α -hydrogen dominates the pathway (eq 27b).

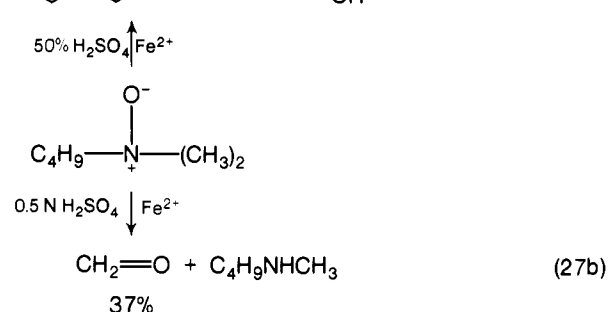
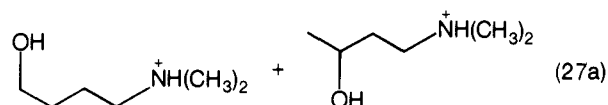

The radicals generated by flash photolysis of *N*-chloro- and *N*-nitrosopiperidine^{99,100} at pH 2, gave the same absorption spectrum and were not affected by oxygen, suggesting piperi-

dinium radicals were common to both experiments. The observed first-order kinetics of the decay of the piperidinium radical were independent of the concentration of substrates, but the rate constants were slightly different depending on the counter radicals ($\cdot\text{NO}$ and $\cdot\text{Cl}$) which served as hydrogen atom acceptors.

The observed rate constants for hydrogen abstraction by nonaromatic aminium radicals allow several interesting comparisons with other radicals. Although not determined directly, Malatesta and Ingold¹⁹⁰ have calculated that $(\text{CH}_3)_2\dot{\text{N}}\text{H}^+$ abstracts hydrogen from decanoic acid at a rate $(2.4\text{--}3.2) \times 10^2 \text{ M}^{-1} \text{ s}^{-1}$ which may be compared with the data for the piperidinium radical (Table VII). The unhindered $(\text{CH}_3)_2\dot{\text{N}}\text{H}^+$, therefore, is about as reactive as the methyl radical in hydrogen abstractions; it is much more reactive than alkylperoxy or 2,2,6,6-tetramethylpiperidyl and much less reactive than *tert*-butoxy.¹⁹⁰ The reaction of Dabco⁺ with ClO_2 (last entry, Table VII) is discussed in more detail in section IV.C.2.

Kinetic profiles as shown in Table VII are very useful information in designing reaction conditions for syntheses. For example, piperidinium radical addition to cyclohexene is about 5000 times faster than its hydrogen abstraction from methanol; the latter can be used as solvent in nitrosamine photoaddition. No doubt the rate constants of the competing aminium radical reactions vary depending on structures, conditions, and substrates that eventually decide the pattern of the final products.

C. Amine Oxidations: Pathways, Mechanisms, and Kinetics

1. Open-Chain Amines

Horner's amine oxidation studies,^{2,46,47,50,54,65} carried out largely on dialkylanilines, were the forerunners of the work on aliphatic amines. Conclusive demonstrations of aminium radical intermediates and their properties in nonaromatic amine oxidations awaited the felicitous choice of reactants and experimental conditions. These, it would appear, are surprisingly limited. The most important requirement was for stable UV or visible light-absorbing true one-electron oxidants of reasonable reactivity; the reduced forms of these would also have to be stable and to exhibit changed UV-visible spectra. The most popular oxidizing agents, Mn(VII) and Cr(VI), were not well suited for such investigations, in that Mn(VI) and Cr(V) are unstable species. Ferric phenanthroline complexes demonstrated decomposition problems,³² and the reduction of octacyanomolybdate(V)³² could not be measured directly by spectroscopy. Only two oxidants appear to have met the basic criteria: chlorine dioxide and ferricyanide ion.

Chlorine dioxide⁴¹ is a useful, easily measured (λ_{max} 357 nm) amine oxidant at pH 5–9 in cold aqueous solution. It is so reactive that kinetic measurements can be conveniently made under pseudo-first-order conditions in which the amines are in excess, but largely tied up as the unreactive water-soluble protonated species. Reaction times can be prolonged or diminished by increasing or decreasing the pH, thereby increasing or decreasing free amine concentration.

The other well-studied, one-electron oxidant is ferricyanide ion, with an absorption maximum at 420 nm.^{26a,32} Unlike many other complexed metal ions, neither the oxidized (ferricyanide) nor the reduced (ferrocyanide) form easily loses its ligands. Ferricyanide ion is less reactive by a factor of over a million than chlorine dioxide with nonaromatic amines.^{26b,32,35} This has necessitated the conduct of most experiments under conditions in which the amines are predominantly in the unprotonated form, namely at pH levels above 12. To dissolve the required concentrations of the amines, it has usually been necessary to employ mixed organic-aqueous solvents, such as *tert*-butylamine-water^{26a} or methanol-water.^{27,29,30}

a. Reaction Pathways

Among open-chain aliphatic and arylalkyl monoamines, the order of reactivity with chlorine dioxide³⁵ and ferricyanide ion^{26a} is tertiary > secondary > primary.³⁵ This is to be expected for electron transfer from nitrogen, since the alkyl groups are electron-donating inductive substituents.²⁶ Reaction with primary amines is generally so slow³⁵ that nearly all investigations have been carried out with tertiary and (less frequently) secondary amines. What little has been done on primary amines suggests the importance of parallel hydrogen-abstraction pathways.^{33,36}

In oxidation of open-chain aliphatic or arylalkylamines involving aminium radical intermediates, the general pathway appears to be as shown by eq 28–30.^{28,29,35,36} It may be noted

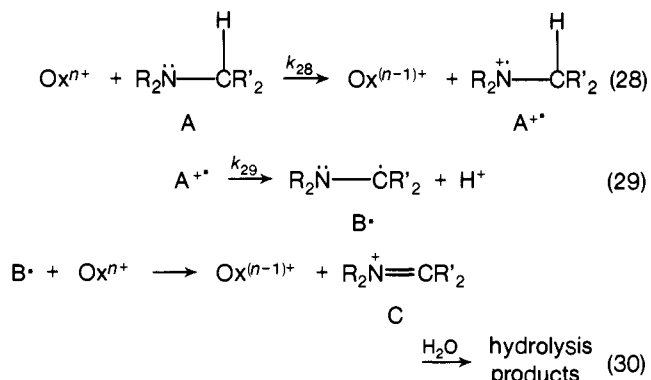

that this is the same sequence as postulated for electrochemical oxidation (cf. eq 12) and that the two oxidation steps are separated by the loss of a proton. With benzoyl peroxide as the oxidant, the aminium radical ($\text{A}^{+\cdot}$) is believed to be formed by a bond-breaking process (see section II, eq 3 and 4). According to Horner and Kirmse,⁵⁴ the reaction following deprotonation in an aroyl peroxide oxidation is a coupling of the relevant radicals leading to a carbinolamine derivative (D) (eq 31) instead of a second oxidation to an iminium ion (C). The controlling feature is whether oxidation or coupling of the radicals is faster.

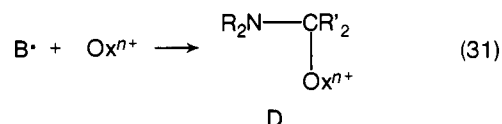

The oxidation of amines in benzene with 1-chlorobenzotriazole has been formulated as a more complicated variant of the same mechanism.⁴³

Great care must be taken to distinguish between mechanisms such as the foregoing and hydrogen abstractions that do not occur by way of aminium radicals. Thus, in parallel reactions with chlorine dioxide, dibenzylamine underwent 35% hydrogen abstraction and 65% electron transfer.³⁶ Moreover, it would appear that the permanganate oxidation of trimethylamine proceeds entirely through electron transfer,³³ whereas the same oxidant acts on benzylamine predominantly by hydrogen (or hydride) abstraction.¹⁶

The overall stoichiometry in steps 28–30 is as shown in eq 32; thus, the stoichiometric ratio of amine to oxidant is 1:2, provided the amine is in good excess.^{26a,b,34}

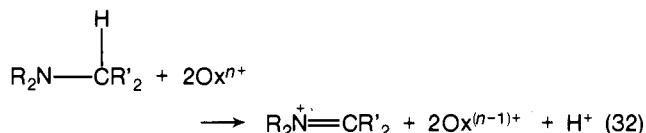

b. Mechanisms in the Oxidation of Open-Chain Amines

In demonstrating the validity of steps 28–30, it was most

crucial to establish the intermediacy of the cation radical A^+ . If only one mechanism is operative, the first-order dependency on the one-electron oxidant,^{26a,b,34-36} forces the choice of either a neutral free radical intermediate (by hydrogen abstraction) or the cation radical. Several lines of evidence indicated that the aminium radical is the dominant first-step oxidation product in most cases. (1) Kinetic isotope effects were secondary, rather than primary for chlorine dioxide,³⁶ ferricyanide,²⁹ and permanganate³³ oxidations of α -deuterated tertiary amines. (2) Demethylation was favored over debenzoylation of dimethylbenzylamines by chlorine dioxide,³⁵ although preferential phenyl activation of the α carbon should be observed in the case of hydrogen abstraction. (3) Whereas the rate-determining steps for ferricyanide oxidation of *N*-methyl-*n*-butylamine and *N*-deuteriomethyl-*n*-butylamine proceed at practically the same rate, the product-determining rate constant for the hydrogenated methyl was 3.6 times that for the deuterated methyl.²⁹ Were the product-determining steps in the hydrogen-transfer mechanism to differ by such a large factor, this would be reflected in substantially different observed reaction rates for the labeled and unlabeled compounds. (4) The existence of two mechanisms (one retarded by added chlorite ion, the other not) for chlorine dioxide oxidation of benzyl-*tert*-butylamine indicated an instance where both hydrogen and electron abstraction must be inferred.³⁶ (5) The reversibility of chlorine dioxide oxidations^{35,36} and of low-pH ferricyanide oxidation³² by chlorite ion and ferrocyanide ion, respectively, can best be rationalized in terms of electron transfer. (6) Both cationic salt effects and the large negative Taft ρ^* values (< -5) seen for chlorine dioxide and ferricyanide oxidations of tertiary amines suggested electron transfer with the development of a high degree of positive charge in the transition state.^{26a,b} The linear trend between enthalpy and entropy of activation for ferricyanide oxidation of the tertiary amines studied by Audeh and Lindsay Smith,^{26a} and the linearity of their Taft plots,^{26b} indicated that these oxidations all occur by the same mechanisms, which the preponderance of evidence showed to be electron transfer.

Reaction 29, loss of a proton to form a neutral free radical, ordinarily represents a better alternative than immediate oxidation of the positively charged aminium radical by an electrophilic reagent, i.e., eq 33. Moreover, reaction 33a would require

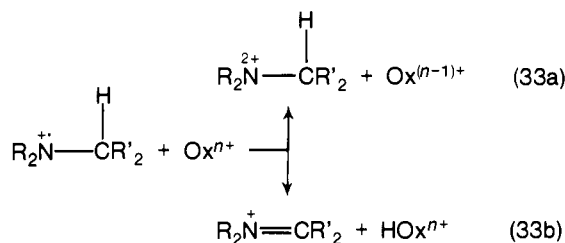

imposition of a double positive charge on an isolated nitrogen. A stronger argument against reaction 33 comes from consideration of the first-order oxidations by chlorine dioxide³⁶ as well as low-pH ferricyanide oxidation.³² In these cases, the reduced form of the oxidant retards reaction through reversal of the first step.

Lindsay Smith and co-workers^{26,29} have accepted reaction 29 for high-pH ferricyanide oxidations of tertiary amines. Here the rate-limiting reaction is reaction 28, since the rate is unaffected by added ferrocyanide, hence irreversible.^{26a} Thus, the kinetic evidence for an intervening proton loss cannot be invoked for the ferricyanide reactions, but reaction 29 still represents a reasonable hypothesis for these reactions.

For an unsymmetrical tertiary amine, the dealkylation pattern seen in the ultimate products represents proton loss from one alkyl group or another. With chlorine dioxide as the oxidant, the loss appeared to be statistical³⁵ and the overall reaction rate was essentially unaffected by pH. In contrast, proton loss patterns

in ferricyanide oxidations were shown to depend on the relative acidities of the respective α hydrogen in the aminium radicals.^{26a,b}

Product distribution, as indicated above, was greatly affected by deuteration of the methyl group of *N*-methyl-*n*-butylamine;²⁹ the ratio of methyl oxidation to butyl oxidation was 3.1:1 in the protonated compound and 0.86:1 in the deuterated compound. The oxidation of intermediate B \cdot to C (eq 30) was demonstrated convincingly by Audeh and Lindsay Smith^{26c} through the cyclization of certain amino alcohols, albeit in low yield (e.g., eq 34).

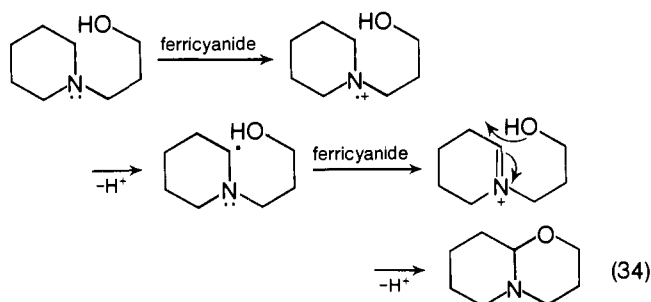

The formation of a carbinolamine, either from product C or D in eq 30 and 31, respectively, was inferred from the formation of the corresponding amide by further oxidation when ferricyanide was in excess.^{26a} Corresponding conditions of excess oxidant were not explored with chlorine dioxide.

Hydrolysis of iminium ions (C) or of carbinolamines obtained by oxidizing tertiary amines normally produces the expected secondary amines and carbonyl compounds, e.g., eq 35.

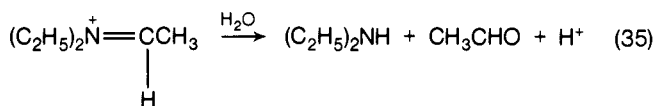

Although an iminium ion from oxidation of a secondary amine, for example, $\text{RN}^+\text{H}=\text{CCH}_3$, can dissociate to give the imine, the latter is also subject to hydrolysis. Carbinolamines and imines may be hydrolytically stable, however, when incorporated into rings of proper structure.

c. Kinetics of Open-Chain Amine Oxidations

Table VIII presents some typical values for k_{28} in chlorine dioxide oxidations of open-chain amines.^{26a,36} Changes in reaction conditions from one publication to the next make it difficult to compare ferricyanide oxidation data. Thus, the rate constant for *N*-methyl-*sec*-butylamine at 30 °C in *tert*-butylamine-water (32:68) and 0.5 N sodium hydroxide^{26a} is $0.23 \text{ M}^{-1} \text{ s}^{-1}$; in methanol-water (30:70) containing 0.25 N potassium hydroxide and 1 M cesium chloride,^{26b} the value is $0.53 \text{ M}^{-1} \text{ s}^{-1}$. Cation effects can be rather large, as shown in Table IX. In addition, the degree of substitution on the nitrogen center affects the rate of oxidation. In the pH range 7.5–8.0, the values of k_{28} for potassium permanganate at 25 °C were $46 \text{ M}^{-1} \text{ s}^{-1}$ for triethylamine, $1.4 \text{ M}^{-1} \text{ s}^{-1}$ for diethylamine and $0.12 \text{ M}^{-1} \text{ s}^{-1}$ for ethylamine.³³ These values may be compared with the electrochemical data in Table II.

The inductive effects of substituents near the tertiary amine nitrogen have been explored for oxidations with ferricyanide ion by Lindsay Smith and Mead.³⁰

2. Oxidative Fragmentation Reactions

Chlorine dioxide was shown³⁷ to cleave a number of bifunctional amines of the structural type E according to the general pathway shown by eq 36.

TABLE VIII. Selected Electron Abstraction Rate Constants (k_{28}) for Reactions of Open-Chain Amines with Aqueous Chlorine Dioxide

Amine	pK_a	$M^{-1} s^{-1}$	Temp. °C	pH	Ref
Triethylamine	10.78	1.1×10^5	26.5	7.14	36
Trimethylamine	9.92	5.0×10^4	25.2	7.20	36
Benzyltrimethylamine	9.03	1.4×10^4	27.0 ^a	<i>b</i>	35
<i>p</i> -Methoxybenzyltrimethylamine	9.32	2.5×10^4	27.0 ^a	<i>b</i>	35
<i>p</i> -Nitrobenzyltrimethylamine	8.14	2.2×10^3	27.0 ^a	<i>b</i>	35
Diisopropylamine	11.01	1.8×10^2	25.0	8.93	36
Dibenzylamine	8.43	2.7×10	40.7	7.08	36
Diethylamine	11.0	1×10^3	26.5	7.14	34
Benzylamine	9.60	5.6×10^{-3}	25.0	8.96	36

^a Temperature measured in cell compartment. ^b Various pH values.

TABLE IX. Cation Effects on the Ferricyanide Oxidation of *N*-Methyl-*sec*-butylamine at 25 °C^{a,b}

Base	k_2^c , $M^{-1} s^{-1} \times 10$	Salt	k_2^c , $M^{-1} s^{-1} \times 10$
LiOH	1.6	KCl	8.6
NaOH	1.5	RbCl	14.2
KOH	8.6	CsCl	30.6

^a 1.8×10^{-3} M $K_3Fe(CN)_6$; 1.8×10^{-2} M amine; 0.5 M salt or base in *tert*-butylamine–water (32:68). ^b Reference 26a. ^c The value of k_2 is for the rate equation $-d[\text{amine}]/dt = k_2[\text{amine}][\text{ferricyanide}]$.

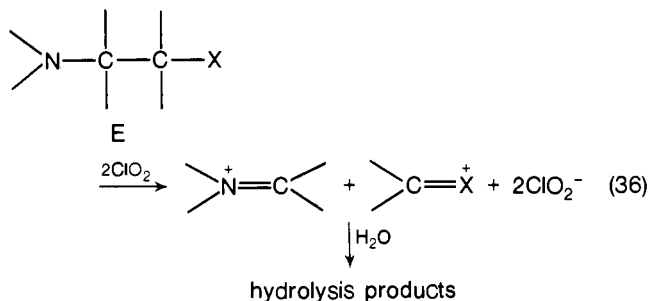

Thus

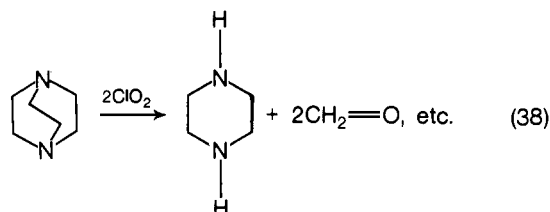
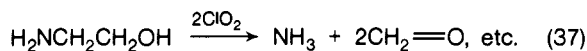

Reactions 37 and 38 also occur with hypochlorous acid, but the cation radical need not always be an intermediate. With the exception of the oxidation of Dabco,^{39,40,51} these reactions have not been thoroughly investigated, and even the reaction orders are not known. Interestingly, the kinetics of oxidation of triethanolamine with alkaline ferricyanide³¹ showed first-order dependency on each reagent and the expected fragmentation products (eq 39):

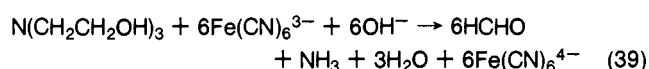

The authors³¹ cited failure to catalyze vinyl polymerization to rule out a free-radical mechanism, but that criterion is probably not valid; chlorine dioxide–triethylamine mixtures, which certainly generate aminium radicals, do not initiate acrylonitrile polymerization even though hypochlorite–triethylamine mixtures are able to do so.³⁴

The reaction kinetics of Dabco with chlorine dioxide at 25 °C

proved especially amenable to examination, and this system has been studied in detail.⁴⁰ The reaction proceeds as shown by eq 40–43, and the following rate constants were determined: $k_{40} = 4.05 \times 10^4 M^{-1} s^{-1}$, $k_{-40} = 4.57 \times 10^5 M^{-1} s^{-1}$, $k_{41} = 1.31 \times 10^4 M^{-1} s^{-1}$. The value for k_{40} is nearly 50 times as great as would be predicted from the Taft σ^* value for Dabco.^{38,40}

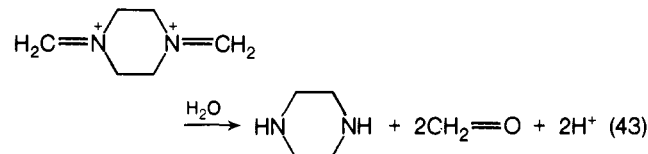
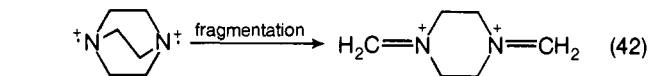
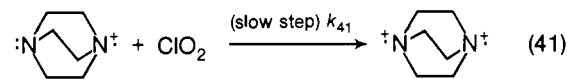
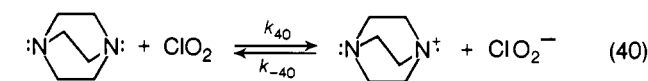

The value of k_{40} for the oxidation of Dabco by ferricyanide^{29,30} in methanol–water (30:70) and 0.5 M potassium hydroxide is $3.53 \times 10^{-4} M^{-1} s^{-1}$. The mechanism and products of this reaction were not determined. Presumably the reaction kinetics were first order.

The oxidation of Dabco by hypochlorous acid has also been studied in considerable detail by Rosenblatt and co-workers.^{39,51} At least two distinct mechanisms were considered, one involving 80% product formation via a heterolytic (two-electron change) pathway and only 20% via homolysis. In the less favored mechanism all product formation occurred through the heterolytic route.

It is important to note that steric and resonance effects strongly influence the choice and relative importance of mechanisms available for Dabco oxidation. Thus, the intermediate **33**, analogous to intermediates formed in the oxidation of

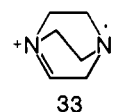

open-chain aliphatic amines, is forbidden according to Bredt's rule,⁵¹ whereas the stability of the Dabco radical cation is enhanced by delocalization of the odd electron.³⁹ If homolysis to produce aminium and chlorine radical plays such a minor role in the hypochlorous acid oxidation of Dabco, where the aminium radical has enhanced stability, it should play an even smaller part in the corresponding reaction of open-chain aliphatic amines.

The difference between the ease of oxidation of quinuclidine and open-chain amines as discussed in section III.B has also been observed in the reaction of that compound with nitrous acid¹⁹ (not via an aminium radical) and with ferricyanide ion.²⁹ Lindsay Smith and Mead²⁹ have studied the reaction of the latter

oxidizing agent with quinuclidine and observed a very slow rate which they attributed as due to the inability of the bridgehead aminium radical to assume a planar configuration. This conclusion is supported by the ESR results reported in section III.A.

Although these authors measured reaction rates, they did not identify the reaction products. It may well be that the very slow reaction of quinuclidine with ferricyanide ion gives an unusual product, as is observed in the slow reaction of quinuclidine with chlorine dioxide. In the latter example,¹⁹² the isolated organic product is the *N*-oxide; chlorate and chloride ions are formed and only a small amount of chlorite ion is to be seen.

In contrast to the low reactivity of quinuclidine with oxidizing agents, the compound with one more methylene group in each bridge, namely, 1-azabicyclo[3.3.3]undecane (**27**), was extremely susceptible to oxidation, being 3.5 million times as reactive with ferricyanide as quinuclidine.¹⁹³ Here, obviously, the assumption of a planar configuration around the nitrogen is energetically preferred relieving angular strain as discussed in sections III.A and III.B. Even in the monocyclic series, *N*-methylpiperidine, *N*-methylhexamethylenimine, and *N*-methylheptamethylenimine, the rate constants increased dramatically,²⁹ in the ratio 1:420:1072. Lindsay Smith and Mead^{29,30} have discussed various examples among cyclic amines that illustrate the interaction of steric, inductive, and field effects on the reactivity of amines with ferricyanide ion.

This area of investigation is far from exhausted. Much remains to be done with chlorine dioxide to parallel the most recent results with ferricyanide ion.

D. Hydrogen Atom Abstractions

1. Intramolecular Reactions

The highly stereospecific hydrogen abstraction by aminium radical is the key step in the intramolecular functionalization at the 5-position (from the radical center) and, in turn, a simple and efficient synthesis of pyrrolidine derivatives in the Hofmann-Löffler reaction (eq 44). Not only *N*-chlorodialkylamines but

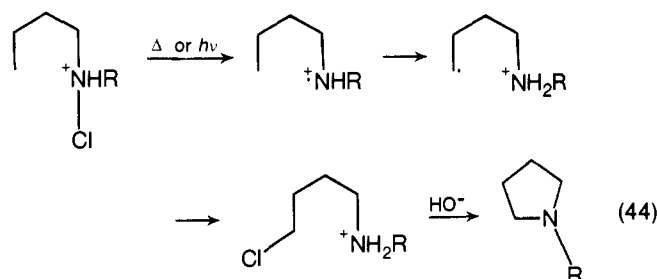

N-bromodialkylamines⁵ and *N*-chloromonoalkylamines¹⁹⁴ are also used for the rearrangement. This reaction has been reviewed three times⁶⁻⁸ in recent years in addition to the original review by Wolff⁵ and the details will not be covered. This process also occurs with the aminium radicals generated by other methods such as nitrosamine photolysis^{195a} or ferrous ion catalyzed decomposition of amine oxides^{20a} provided other fast reaction pathways do not supersede.

While selectivity of functionalizing 5-positions seems to be overwhelming, there are some scattered examples of functionalization at 6-positions; in the Hofmann-Löffler reaction, for example, rearrangement of *N*-chloromethylhexylamine gave 2% of *N*,2-dimethylpiperidine⁷¹ while *N*-chloromethyl-5-phenylpentylamine gave 26% of methyl-5-phenyl-5-hydroxypentylamine^{195b} in addition to the expected pyrrolidine derivatives (see Table X).

Some pertinent examples of the Hofmann-Löffler reaction are summarized in Table X. The scattered examples of functionalization at the 6-positions (no. 2 and 3) might be explained

as abstraction of ω -1 hydrogens⁸ and preferred benzylic hydrogen abstraction by intermolecular rather than genuine intramolecular processes. Metal ion catalyzed *N*-chlorodimethylamine decomposition in the presence of hexylamines produced only 2-methylpiperidine derivatives in 60–65% yield.¹⁹⁶ These arise from the intermolecular (ω -1) functionalization by the dimethylaminium radical (see section IV.D.2). Aminium radicals also show preferential hydrogen abstraction⁷¹ in the order of tertiary > secondary > primary provided no serious steric strain or hindrance are involved.

Application of the Hofmann-Löffler-type cyclization finds many elegant pyrrolidine derivative syntheses in natural product chemistry; among them are nicotine from *N*-bromo-*N*-methyl-1-(3'-pyridyl)butylamine²⁰⁰ and conanine derivatives from certain 20-methylamino steroids.²⁰¹ More recently,²⁰² the stereoisomers of meroquinine (3-vinyl-4-piperidineacetic acid), which is a biogenetic precursor of quinine and quinidine, were also synthesized by the same principle in good yields (eq 45).

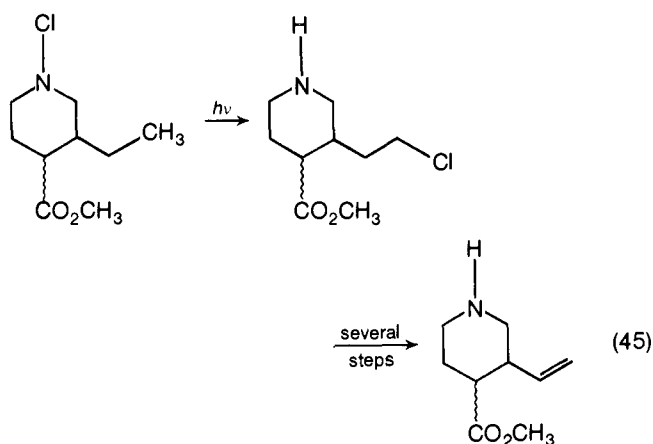

The factors contributing to a successful Hofmann-Löffler reaction are somewhat difficult to define owing to the fact that crude chloramines are generally used for reaction without purification. Careful exclusion of chlorine, high acidity of the reaction media, utilization of light or an initiator to speed up the radical pathways, and exclusion of inhibitors such as oxygen may eliminate various dark reactions to give higher yields of the desired products.^{8,71}

2. Intermolecular Reactions

Intermolecular hydrogen abstraction by aminium radicals is generally investigated by decomposition of haloamines^{90,203-213a} in highly acidic media, e.g., 20–100% H₂SO₄, in the presence of a suitable substrate (S-H), though recently amine oxides and hydroxylamine⁶³ have also been used. While haloamine decomposition gives the halogenated products according to the radical chain mechanism similar to the Hofmann-Löffler reaction

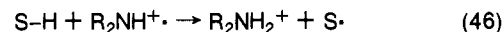

in the latter cases the C-radical intermediate is oxidized by ferric ion to the carbonium ion followed by combination with an available nucleophile,^{63,190} e.g., trifluoroacetic acid used as solvent (eq 49 and 50). Overall, the net result is oxidation mediated by an aminium radical chain carrier. While ferrous ion is the usual catalyst, initiation of the radical chain reaction also

TABLE X. Representative Examples of Hofmann-Löffler Reaction

	Haloamines	Product	Yield, %	Solvent	Condition	Ref
1.			35	H ₂ SO ₄	Δ, 95°	71
2.			17	H ₂ SO ₄	hν, 0°	71
3.			43	4 M H ₂ SO ₄ AcOH	hν, 20°	196
4.			26	4 M H ₂ SO ₄ AcOH	hν, 20°	196
5.			>90	40% H ₂ SO ₄	Δ, 80°	8
6.				TFA ^a	hν	197
7.			72	50% H ₂ SO ₄	FeSO ₄	64
8.			15	TFA ^a	hν	198
9.		As above	70	TFA ^a	hν	198
10.			30	TFA ^a	hν	199

^a Trifluoroacetic acid.

TABLE XI. Oxidation/Halogenation of Aliphatic Compounds

No.	Reagent ^b	Product distribution ^a	Conditions ^c	Ref
1	CMA	CH ₃ CH ₂ CH ₂ -CO ₂ Me 14 86	FeSO ₄	204
2	CMA	CH ₃ CH ₂ CH ₂ CH ₂ -CO ₂ Me 7 77 16	FeSO ₄	203-206
3	BMA	CH ₃ CH ₂ CH ₂ CH ₂ -CO ₂ Me 12 81 6 0.5	FeSO ₄	207
4	CMA	CH ₃ CH ₂ CH ₂ CH ₂ CH ₂ -CO ₂ Me 6 87 6 0.7	FeSO ₄ or CuCl	203, 204 206-208
5	BMA	CH ₃ CH ₂ CH ₂ CH ₂ CH ₂ -CO ₂ Me 7 87 6 0.4	FeSO ₄	207
6	CBA	CH ₃ CH ₂ CH ₂ CH ₂ CH ₂ -CO ₂ Me 7 90 3	FeSO ₄	209
7	CPA	CH ₃ CH ₂ CH ₂ CH ₂ CH ₂ -CO ₂ H 1 93 6 0 0	FeSO ₄	91

TABLE XI (Continued)

No.	Reagent ^b	Product distribution ^a	Conditions ^c	Ref
8	CMA	CH ₃ CH ₂ CH ₂ CH=CH-CO ₂ Me 8 47 45	FeSO ₄	208
9	CMA	CH ₃ CH ₂ CH ₂ CH ₂ CH ₂ CH ₂ -CO ₂ Me 4 80 15 1	FeSO ₄	203-206
10	BMA	CH ₃ CH ₂ CH ₂ CH ₂ CH ₂ CH ₂ -CO ₂ Me 4 82 13 1	FeSO ₄	203
11	CBA	CH ₃ CH ₂ CH ₂ CH ₂ CH ₂ CH ₂ -CO ₂ Me 6 83 10 0.8	FeSO ₄	211
12	CPA	CH ₃ CH ₂ CH ₂ CH ₂ CH ₂ CH ₂ CH ₂ -CO ₂ H 1 80 14 5 0 0 0	FeSO ₄	91
13	CPA	CH ₃ CH ₂ -CH ₂ CH ₂ CH ₂ -CH ₂ CH ₂ -CONH ₂ 8 59 11 13 8 2 0	FeSO ₄	91
14	CMA	CH ₃ CH ₂ CH ₂ CH ₂ CH ₂ CH ₂ CH ₂ CH ₂ -CO ₂ Me 1.1 44 22 18 11 4 0.5	FeSO ₄	210
15	CBA	CH ₃ CH ₂ CH ₂ CH ₂ CH ₂ CH ₂ (CH ₂) ₃ -CO ₂ Me 1 58 19 13 7 2	FeSO ₄	204
16	CMA	CH ₃ CH ₂ CH ₂ CH ₂ CH ₂ CH ₂ CH ₂ (CH ₂) ₂ -CO ₂ H 1 44 22 17 11 4 0.5	FeSO ₄	90
17	CMA	1 39 23 16 13 6 2	ACHN/hν	90
18	CPD	1 41 18 18 13 7 1	ACHN/hν	90
19	CMA	CH ₃ CH ₂ CH ₂ CH ₂ CH ₂ -OAc 6 88 6	FeSO ₄	209
20	CMA	CH ₃ CH ₂ CH ₂ CH ₂ CH ₂ (CH ₂) ₂ -OAc 3 79 16 2	FeSO ₄	209
21	CBA	CH ₃ CH ₂ CH ₂ CH ₂ (CH ₂) ₂ -OAc 4 85 10 0.8	FeSO ₄	209
22	CPA	CH ₃ CH ₂ CH ₂ CH ₂ CH ₂ CH ₂ -OMe 8 92 0 0 0	FeSO ₄	91
23	CMA	CH ₃ CH ₂ CH ₂ CH ₂ CH ₂ CH ₂ -OMe 4 83 12 1 0 1.0	FeSO ₄	209
24	BMA	CH ₃ CH ₂ CH ₂ CH ₂ CH ₂ CH ₂ -OMe 4 83 12 1	FeSO ₄	203
25		CH ₃ CH ₂ CH ₂ CH ₂ CH ₂ -OH 12 77 7 4 0		8
26	CPA	CH ₃ CH ₂ CH ₂ CH ₂ (CH ₂) ₂ -OH 6 90 2 2 0	FeSO ₄	91
27	CPA	CH ₃ CH ₂ CH ₂ CH ₂ CH ₂ CH ₂ (CH ₂) ₂ -OH 0.5 92 3 1 1.5 2 0	FeSO ₄	91
28		CH ₃ CH ₂ -(CH ₂) ₄ -NH ₂ >65%	FeSO ₄	196
29	CMA	CH ₃ CH ₂ CH ₂ CH ₂ Cl 5 89 6	FeSO ₄	203-205
30	CMA	6 79 11 5	AIBN/Δ	90
31	CPD	6 78 10 5	FeSO ₄ or CuCl	90
32	CPD	6 78 10 5	ACHN/hν	90
33	BMA	CH ₃ CH ₂ CH ₂ CH ₂ -Cl 7 79 9 4	FeSO ₄	90, 203
34	CMA	CH ₃ CH ₂ CH ₂ CH ₂ CH ₂ -Cl 4 77 16 3	FeSO ₄	204
35	CMA	CH ₃ CH ₂ CH ₂ CH ₂ CH ₂ CH ₂ -Cl 2 73 20 4 1	FeSO ₄	203-205
36	CPA	(CH ₃ -CH ₂) ₂ -CH ₂ 4 74 22	hν, 84% H ₂ SO ₄ 15°	214
37	CTP	6 85 9	TFA, hν 15°	214
38	CMA	(CH ₃ CH ₂ CH ₂) ₂ CH ₂ 1 56 29 14	FeSO ₄	203, 210
39	BMA	1 50 33 16	FeSO ₄	203
40	Et ₃ NO	CH ₃ CH ₂ CH ₂ CH ₂ CH ₂ CH ₂ CH ₂ CH ₂ -O CO CF ₃ 0 72 22 5 1 0 0	FeSO ₄ , TFA, 70°	63
41	Et ₂ NOH	CH ₃ CH ₂ CH ₂ CH ₂ CH ₂ CH ₂ CH ₂ -O CO CF ₃ 0 58 31 9 2 0 0	FeSO ₄ , TFA, 70°	63
42	Et ₃ NO	CH ₃ CH ₂ CH ₂ CH ₂ (CH ₂) ₂ CH ₃ 0 51 37 12	FeSO ₄ , TFA, 70°	63
43	Et ₂ NOH	CH ₃ CH ₂ CH ₂ CH ₂ (CH ₂) ₂ CH ₃ 0 42 41 17	FeSO ₄ , TFA, 70°	63
44	Et ₃ NO	CH ₃ CH ₂ CH ₂ CH ₂ (CH ₂) ₂ CH ₃ 0 36 28 36	FeSO ₄ , TFA, 70°	63
45	Et ₂ NOH	CH ₃ CH ₂ CH ₂ CH ₂ (CH ₂) ₅ CH ₃ 0 27 26 45	FeSO ₄ , TFA, 70°	63

^a The reactions were run to various stages of completion; the yield calculated on the basis of conversion is generally in the range of 50-80%. ^b CMA = *N*-chlorodimethylamine; BMA = *N*-bromodimethylamine; CPA = *N*-chlorodiisopropylamine; CPD = *N*-chloropiperidine; CTP = *N*-chloro-2,2,6,6-tetramethylpiperidine; CBA = *N*-chlorodiisobutylamine. ^c AIBN = azobisisobutyronitrile; ACHN = azobiscyclohexyltrinitrile.

TABLE XII. Photolytic Chlorination with Chloramines at 15 °C. Relative Reactivity of Alkyl Hydrogen toward Aminium Radicals

Compound ^a	Substrate	Relative reactivity				Conditions	Ref
		C-1	C-2	C-3	C-4		
1. CPA	CH ₃ (CH ₂) ₃ CH ₃	1	28.0	17.0		84% H ₂ SO ₄	214
2. CTP	CH ₃ (CH ₂) ₃ CH ₃	1	19.4	4.1		TFA	214
3. CTP	CH ₃ (CH ₂) ₃ CH ₃	1	21.5	4.0		10% H ₂ SO ₄	214
4. CMA	(CH ₃) ₂ CHCH ₂ CH ₃	1	3.1	2.9	1	30% H ₂ SO ₄	216
5. CPA	(CH ₃) ₂ CHCH ₂ CH ₃	0.5	0.2	6.2	1	TFA	214
6. CTP	(CH ₃) ₂ CHCH ₂ CH ₃	0.4	0.0	2.8	1	TFA	214
7. CMA	(CH ₃) ₃ CCH ₂ CH ₃	1		3.6	1	30% H ₂ SO ₄	216
8. CPA	(CH ₃) ₃ CCH ₂ CH ₃	0.9		1.36	1	10% H ₂ SO ₄ -TFA	214
9. CTP	(CH ₃) ₃ CCH ₂ CH ₃	0.12		0.27	1	10% H ₂ SO ₄ -TFA	214
10. CTP	(CH ₃) ₃ CCH ₂ CH ₃	0.08		0.37	1	TFA	214
11. CTB ^b	(CH ₃) ₃ CCH ₂ CH ₃	1		2.1	1	30% H ₂ SO ₄	216
12. CMA	(CH ₃) ₂ CHCH(CH ₃) ₂	1	3.8			30% H ₂ SO ₄	216

^a The abbreviations of chloramines follow those of Table XI. ^b *N*-Chlorodi-*tert*-butylamine.

occurs by other metal ions (cuprous, titanous, cerous ions);⁹⁰ for *N*-chloroamines it also occurs by photolysis or thermolysis in the presence or absence of initiators, such as azobisisobutyronitrile and azobiscyclohexyl nitrile (AIBN and ACHN).⁹⁰ When straight-chain aliphatic derivatives, e.g., esters, carboxylic acids, alcohols, halides, or alkanes, are used as the substrates (S-H), the oxidations show some outstanding features in comparison to those using chlorine, bromine, or alkoxy radical chain carriers.^{90,205} As shown in Table XI these processes give (i) an extremely high proportion (~90%) of monooxidation product even if the reaction is run to near completion in some cases and (ii) high selectivity of oxidizing the so-called ω-1 position. Comparisons of these selectivities with those from photoinitiated chlorine and bromine radical oxidation are remarkable.^{90,205} Surprisingly, aliphatic hydrocarbons and halides, despite their insolubility in these solvent systems, can be oxidized in heterogeneous mixture with the observed selectivities.

The characteristic electrophilic nature of aminium radicals is shown by their failure to abstract hydrogen next to carboxylic acid or cyano (electron withdrawing, in general) groups. Additional evidence of the electrophilic character is given by the relative reactivity of hydrogen abstraction from ring-substituted toluenes (ρ value = -1.24 for piperidinium radical).^{213b,c}

Intermolecular hydrogen abstraction by aminium radicals is very sensitive to steric controls. *N*-Chlorodiisopropylamine (CPA) gives better ω-1 oxidation than *N*-chlorodimethylamine (CMA). However, for the very bulky *N*-chlorodi-*tert*-butylamine and *N*-chloro-2,2,6,6-tetramethylpiperidine (CTP), while the ω-1 is still the most favored position, the ω position appears to gain more oxidation.^{214,216} As shown in Table XII the aminium radical generated from the latter abstracts the primary hydrogen more efficiently than the secondary which, in turn, is abstracted more easily than the tertiary.^{214,216} Further, in accord with this steric effect, trialkylaminium radicals (entries 40, 42, 44, Table XI) exhibit higher selectivity than the corresponding dialkylaminium radicals (entries 41, 43, 45).⁶³

The remarkable selectivity and clean products displayed by aminium radical chain processes share some similarity with enzymatic action in attacking a specific position near the end of an aliphatic chain and has been alleged as an "enzyme mimetic reaction".²¹⁴ in highly acidic media, sufficiently high to protonate a substrate totally, the hydrogen abstraction naturally favors an end position, remote from the protonated center, because of electrostatic repulsion of the positive charges. In addition to electrostatic and steric effects, it is believed that an aliphatic chain is coiled in a foiled conformation in polar environments which also favors the observed selectivity.

Oxidation of cyclic alkanes by aminium radicals is another interesting reaction. While cyclohexane,^{63,212} norbornane,²¹⁵ and bicyclo[2.2.2]octane²¹⁵ are oxidized to give high yields of monofunctional derivatives at high conversions, adamantane

gives a high yield of 1,3-dichloroadamantane.²¹⁵ Selectivity in monochlorination of polycyclic hydrocarbons as shown below demonstrates the interesting controls of steric strains and hindrance on hydrogen abstraction by aminium radicals. While monochlorination of adamantane by the aminium radical chain process is clearly selective for the bridgehead position, those of norbornane and bicyclo[2.2.2]octane are inferior to selectivity shown by ·Cl and ·CCl₃ radical chain processes.²¹⁵

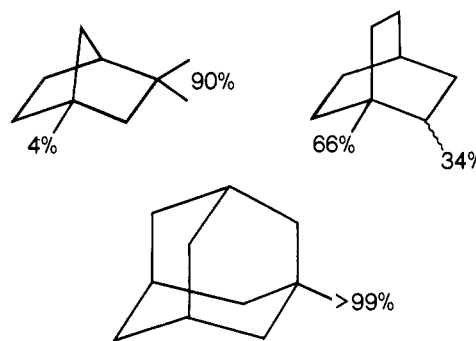

E. Addition to Olefins

1. Intermolecular Processes

One of the unique characteristics of aminium radicals is their propensity to add to a carbon-carbon multiple bond in preference to allylic hydrogen abstraction from olefins and acetylenes. Their cationic nature renders them powerful electrophiles that, however, can only undertake radical pathways. This property is in sharp contrast to other types of radicals that tend to favor hydrogen abstraction from olefins. The relative reactivity of the piperidinium radical addition to para- and meta-substituted styrenes has been correlated by a Hammett relation to be $\rho = -1.45$ which is indeed the largest ever observed for radical additions but not significantly large in comparison to ρ values of electrophilic additions.²¹⁷ This is interpreted to mean that electrophilic interaction occurs at the ground state but not significantly at the transition state.

Aminium radicals generated from nitrosamines,¹¹ chloramines,^{7,78} and hydroxylamines⁷⁶ all undergo radical chain addition to olefins (Tables XIII and XIV) and acetylenes (Table XV) to give synthetically useful yields of β-substituted amines (eq 51-53).

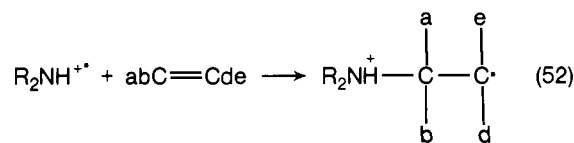

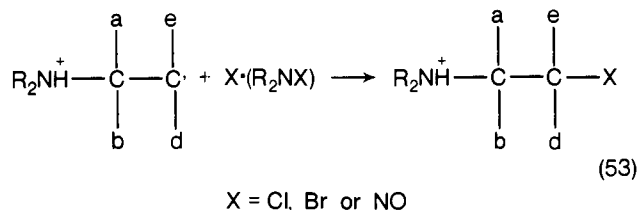

Depending on the reagent and conditions, the C-radical intermediate may react differently; 1-amino-2-nitroso and 1-amino-2-chloroalkanes are the observed products from nitrosamine²¹⁸ and chloramine²¹⁹ additions, respectively, though the former generally undergo further reactions (vide infra). While nitrosamine photoaddition is run in weakly acidic methanol solution (pH 1 ~ 3), chloramine addition is generally carried out in 4–6 M H₂SO₄ in acetic acid. The reaction patterns exhibit some dissimilarity on account of the vast differences in the reaction media.

Additions with hydroxylamine–metal ion mixtures are carried out in solution ranging from neutral to concentrated H₂SO₄ and the C-radical intermediate may undertake the alternative pathway of dimerization if there is no suitable radical donor.⁸¹ With vanadium ion as the catalyst, it is obvious that oxidation of the C-radical also occurs followed by carbonium ion reaction, to give an amino alcohol (eq 54).⁶⁸ The oxidation process appears to

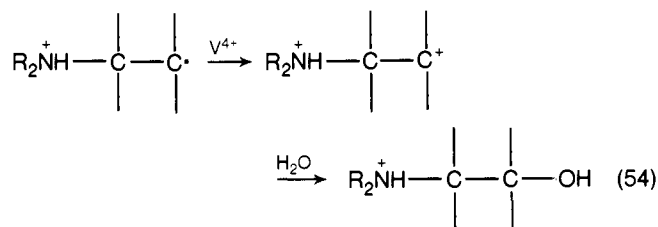

depend on the ionization potentials and the nature of ligands.

Photoadditions of nitroamines^{72,73} and tetrazenes¹⁷⁹ to olefins gave complex mixtures of products. The complexity of reactions of the former is due to the ambident reactivity of the NO₂· radical and the latter to the lack of a good radical donor in the reaction system since the photolysis generates two aminium radicals without giving a counter radical. Under oxygen the photoreactions occur without inhibition and give amino alcohols in good yields after reduction as shown in the addition to 1,5-cyclooctadiene (eq 55b).

In the presence of oxygen, the photoaddition of nitrosamines to cyclohexene is diverted to the formation of 1-amino-2-nitro-

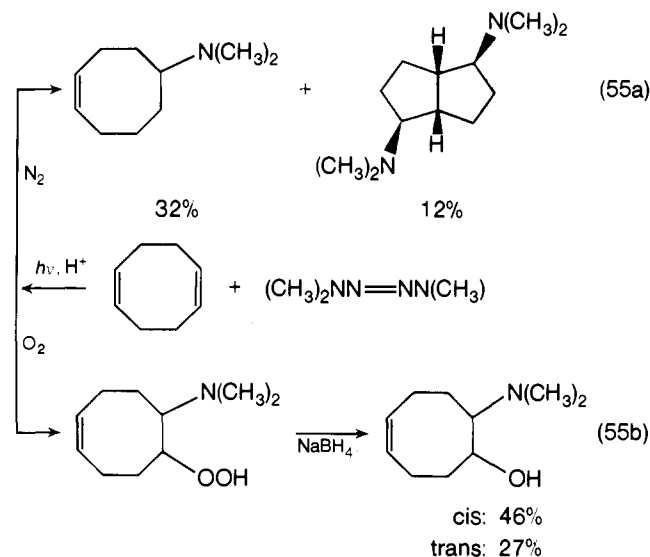

tocyclohexane in a nearly quantitative yield (eq 56).²⁸¹ Evidently oxygen, instead of quenching the photoexcited state of the ni-

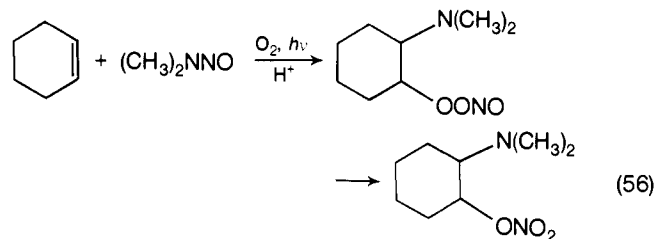

troamine, scavenges the carbon-centered radical; the nitrate is assumed to be formed via the pernitrite intermediate. During ferrous ion catalyzed chloramine addition, trapping of the C-radical intermediates by oxygen (eq 57) and NO (eq 58) was also demonstrated.^{10,79,221}

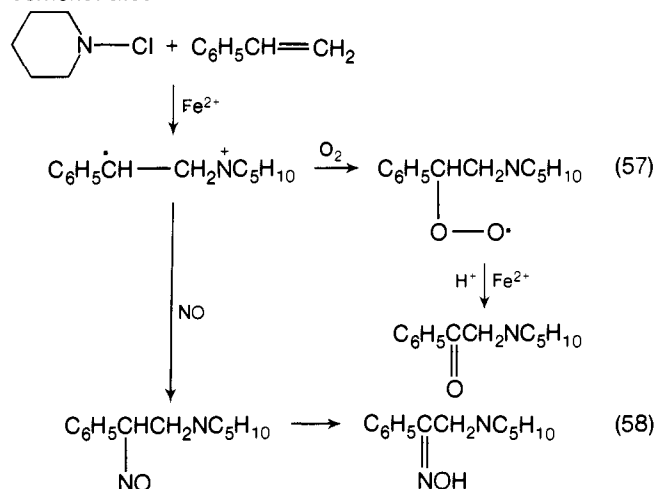

In a highly acidic solvent, chloramines add to norbornadiene and cyclohexene extremely efficiently by ionic pathways, preventing the photoinitiated radical addition from occurring to any significant extent.^{222,223} In contrast, the aminium radicals generated by the photolysis of nitroamines, nitrosamines, and 2-tetrazenes add efficiently to these olefins (Table XIII).^{72,73,179,218} Furthermore, in contrast to the failure of nitrosamine photoaddition to vinyl ethers and esters and acrylic esters,²¹⁷ chloramines add efficiently to electronegatively substituted terminal olefins^{224,225} (see Table XIV). This suggests that under more highly acidic conditions aminium radicals are less likely to lose their α-protons and, therefore, have longer lifetimes during which to interact with the less active olefins.

The nitroso amino derivatives obtained as the primary photoaddition products from nitrosamine addition generally undergo various secondary reactions to give the final products;²¹⁸ the common and major ones are dimerization to give the anti dimers of the C-nitroso compounds and tautomerization (if there is a hydrogen geminal to the nitroso) to give oximes. In addition, several other less common pathways are also operative under certain specific conditions.^{226–228}

While chloramine addition to conjugated dienes and acetylenes (Table XV) occurs spontaneously in H₂SO₄–AcOH solvent,^{219,222} only photolysis can initiate nitrosamine addition to acetylenes.²²⁹ The primary addition products to acetylene are protonated enamines which are rapidly hydrolyzed to α-substituted carbonyl derivatives (eq 59).^{219,229} The relatively low yields

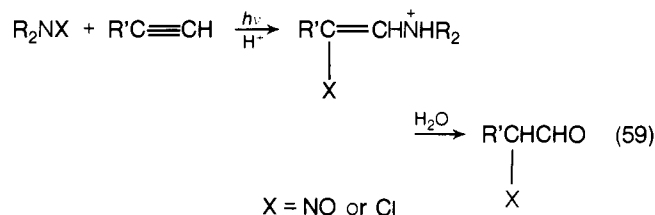

TABLE XIII. Addition to Olefins by Aminium Radicals























































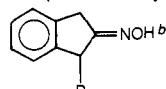
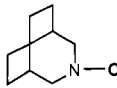
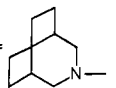
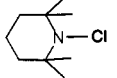
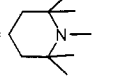

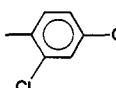

No.	Reagent ^a	Olefin	Condition	Product ^b	Yield	Ref
1	NH ₂ OH		V ₂ (SO ₄) ₃	HOCH ₂ CH ₂ NH ₂	38	68
				HO(CH ₂) ₄ NH ₂	18	
2	<i>n</i> -Bu ₂ NCl		<i>hν</i>	(<i>n</i> -C ₄ H ₉) ₂ NCH ₂ CH ₂ Cl	15	224
3	Et ₂ NCl		Fe(NH ₄) ₂ (SO ₄) ₂	(C ₂ H ₅) ₂ NCH ₂ CHClCH ₃	42	224
4	Et ₂ NCl		Fe(NH ₄) ₂ (SO ₄) ₂	(C ₂ H ₅) ₂ NCH ₂ C(Cl)=CH ₂	35	224
5	<i>n</i> -Bu ₂ NCl		<i>hν</i>	(<i>n</i> -C ₄ H ₉) ₂ NCH ₂ C(Cl)=CH ₂	44	224
6	<i>t</i> -BuNHCl		<i>hν</i>	<i>t</i> -C ₄ H ₉ NHCH ₂ C(Cl)=CH ₂	41	225
7	Et ₂ NCl		Fe(NH ₄) ₂ (SO ₄) ₂	(C ₂ H ₅) ₂ NCH ₂ CHClC ₂ H ₅	33	224
8	<i>n</i> -Bu ₂ NCl		Fe(NH ₄) ₂ (SO ₄) ₂	(<i>n</i> -C ₄ H ₉) ₂ NCH ₂ CHClC ₂ H ₅	16	224
9	NH ₂ OH		TiCl ₃	1,2,3,4-Tetramethyl- tetramethylenediamine CH ₃ CH ₂ CH(NH ₂)CH ₃	12	68
					8	
10	PNO		<i>hν</i>	2-Piperidino-3-butanone oxime	72	230
11	PN \bar{O}		<i>hν</i>	2-Piperidino-3-butanone oxime	70	230
12	NH ₂ OH		TiCl ₃	Diaminooctane	73	68, 231
13	MeNHOH		TiCl ₃	<i>N,N'</i> -Dimethyloctadienes	39	68
14	Et ₂ NCl		FeSO ₄ or CuCl	R ₂ NCH ₂ CH=CHCH ₂ Cl; R = C ₂ H ₅		79
15	<i>n</i> -Bu ₂ NCl		FeSO ₄ or CuCl	R ₂ NCH ₂ CH=CHCH ₂ Cl; R = <i>n</i> -C ₄ H ₉		79
16	M-Cl		TiCl ₃	R ₂ NCH ₂ CH=CHCH ₂ Cl; R ₂ N = 4- morpholino		79
17	<i>n</i> -Bu ₂ NCl			R ₂ NCH ₂ CH=CHCH ₂ Cl; R = <i>n</i> -C ₄ H ₉	60	224
18	(<i>n</i> -C ₅ H ₁₁) ₂ NCl			R ₂ NCH ₂ CH=CHCH ₂ Cl; R = <i>n</i> -C ₅ H ₁₁	42	224
19	C ₆ H ₅ (CH ₂) ₄ N(Cl)CH ₃			C ₆ H ₅ (CH ₂) ₄ N(CH ₃)CH ₂ CH=CHCH ₃	53	224
20	PNO		<i>hν</i>	4-Piperidino-2-butenal oxime	57	232
				1-Piperidinobut-3-en-2-one oxime	26	
21	PNO		<i>hν</i>	1-Piperidino-2-pentanone oxime	97	218
22	NH ₂ OH		FeCl ₂	CH ₃ CH(NH ₂)C(Cl)(CH ₃) ₂	12	81
23	NH ₂ OH		TiCl ₃	Diaminododecadienes	54	233
24	PNO	 or 	<i>hν</i>	1-Piperidinopent-2- en-4-one oxime 1-Piperidinopent-3- en-2-one oxime 4-Piperidino-2-hexenal oxime	72(cis) ^c 60(trans) 11(cis) 26(trans) 12(cis) 4(trans)	232
25	Et ₂ NCl			(C ₂ H ₅) ₂ NCH ₂ C(Cl)=C(CH ₃) ₂	11	224
26	NH ₂ OH		FeCl ₂	NH ₂ CH ₂ CH(Cl)C ₄ H ₉	32	81
27	NH ₂ OH		TiCl ₃	2,3-Dibutyltetramethyl- enediamines	10	68
28	NH ₂ OSO ₃ H		FeCl ₂	NH ₂ CH ₂ CH(Cl)C ₄ H ₉	24	75
29	PCI		FeCl ₂	PCH ₂ CH(Cl)C ₄ H ₉ ^b	62	79
30	PNO		<i>hν</i>	1-Piperidino-2-hexanone oxime	57	
31	PNO		<i>hν</i>	1-Piperidino-3,3-dimethyl-2-butanone oxime 1-Piperidino-3,3-dimethyl-2-(<i>N</i> -nitroso- hydroxylamino)butane	17 41	226
32	PNO		<i>hν</i>	2-Piperidinohex-3-en-5-one oxime	85	232
				2-Piperidinohex-4-en-3-one oxime	10	232
33	PCI		<i>hν</i>	(P-CH ₂ CHClCH ₂) ₂ CH ₂ ^b	27	219
34	PNO		<i>hν</i>	1-Formyl-2-piperidinomethyl- cyclopentane oxime 1-Piperidinohex-6-en-2-one oxime	24 20	234
35	PNO		<i>hν</i>	4-Piperidino-3-octanone	54	218
36	Et ₂ NCl		<i>hν</i>	[(C ₂ H ₅) ₂ NCH ₂ CHClCH ₂ CH ₂ CH ₂] ₂	49	219
37	PNO		<i>hν</i>	2-Piperidinoacetophenone oxime	95	218
38	PNO		<i>hν</i>	Acetophenone oxime	91	218
39	DNO		<i>hν</i>	1-(<i>p</i> -Methoxyphenyl)-2-dimethylamino- 1-propanone oxime	78	235
40	PNO		<i>hν</i>	2-Piperidinocyclopentanone oxime	89	218
41	Me ₂ NNO		<i>hν</i>	2-Dimethylaminocyclohexanone oxime	85	218
42	PNO	...	<i>hν</i>	2-Piperidinocyclohexanone oxime	82	236
43	MNO	...	<i>hν</i>	2-Morpholinocyclohexanone oxime	81	236
44	YNO	...	<i>hν</i>	2-Pyrrolidinocyclohexanone oxime	82	236
45	<i>n</i> -Bu ₂ NNO	...	<i>hν</i>	2-Dibutylaminocyclohexanone oxime	38	236
46	PNO		<i>hν</i>	4-Piperidino-2-cyclohexenone oxime 2-Piperidino-5-cyclohexenone oxime	61 4	238
47	PNO		<i>hν</i>	4-Piperidino-2-cyclopentenone oxime 2-Piperidino-4-cyclopentenone oxime	74 7	238
48	Me ₂ NNO	Cyclooctene	<i>hν</i>	2-Dimethylaminocyclooctanone oxime	97	218

TABLE XIII (Continued)

No.	Reagent ^a	Olefin	Condition	Product ^b	Yield	Ref
49	PNO	1,3-Cyclooctadiene	<i>hν</i>	4-Piperidino-2-cyclooctenone oxime	85	238
				2-Piperidino-7-cyclooctenone oxime	11	
50	PNO	1,5-Cyclooctadiene	<i>hν</i>	2-Piperidino-5-cyclooctenone oxime	94	218
51	PNO	Indene	<i>hν</i>		93	218, 237

^a PNO = *N*-nitrosopiperidine. MCl = *N*-chloromorpholine. PCI = *N*-chloropiperidine. MNO = *N*-nitrosomorpholine. YNO = *N*-nitrosopyrrolidine. ^b P = 1-piperidino. ^c c = cis, t = trans.

TABLE XIV. Addition to Olefins Carrying Heteroatoms

No.	Reagent	Olefin	Products	Yield, %	Ref
1	Et ₂ NCl	CH ₂ =CHCl	(C ₂ H ₅) ₂ NCH ₂ CH ₂ Cl ₂	82	224
2	<i>i</i> -Pr ₂ NHCl	CH ₂ =CHCl	<i>i</i> -C ₃ H ₇ NHCH ₂ CHCl ₂	58	225
3	<i>t</i> -BuNHCl	CH ₂ =CHCl	<i>t</i> -C ₄ H ₉ NHCH ₂ CHCl ₂	59	225
4	Et ₂ NCl	CH ₂ =CHF	(C ₂ H ₅) ₂ NCH ₂ CHFCI	80	224
5	<i>t</i> -BuNHCl	CH ₂ =CHF	<i>t</i> -C ₄ H ₉ NHCH ₂ CHFCI	61	225
6	PCI ^a	CH ₂ =CHBr	PCH ₂ CHBrCl	77	224
7	Et ₂ NCl	CH ₂ =CHSi(CH ₃) ₃	(C ₂ H ₅) ₂ NCH ₂ CH(Cl)CH ₂ Si(CH ₃) ₃	65	224
8	Et ₂ NCl	CHCl=CHCH ₃	(C ₂ H ₅) ₂ NCH(CH ₃)CHCl ₂	54	224
9	Et ₂ NCl	CH=CClCH ₃	XCH ₂ CCl ₂ CH ₃ ; X = (C ₂ H ₅) ₂ N	84	224
10	<i>i</i> -PrNHCl ; X = <i>i</i> -C ₃ H ₇ NH	72	225
11	<i>t</i> -BuNHCl ; X = <i>t</i> -C ₄ H ₉ NH	66	225
12	PCI ^a ; X = C ₅ H ₁₀ N	92	224
13	Am ₂ NCl ; X = (n-C ₅ H ₁₁) ₂ N	28	224
14	<i>t</i> -BuEtNCl ; X = (CH ₃) ₃ CNC ₂ H ₅	78	224
15	MeBzNCl ; X = C ₆ H ₅ CH ₂ NCH ₃	27	224
16	CH ₃ N(Cl)CH ₂ CH ₂ C ₆ H ₅ ; X = C ₆ H ₅ CH ₂ CH ₂ NCH ₃	75	224
17	 X = 	84	224
18	 X = 	35	224
19	CH ₃ N(Cl)(CH ₂) ₄ N(Cl)CH ₃	..	[CH ₃ CCl ₂ CH ₂ N(CH ₃)CH ₂ CH ₂] ₂	49	224
20	CH ₃ N(Cl)(CH ₂) ₆ N(Cl)CH ₃	..	[CH ₃ CCl ₂ CH ₂ N(CH ₃)CH ₂ CH ₂ CH ₂] ₂	72	224
21	Et ₂ NCl	CH ₂ =CBrCH ₃	(C ₂ H ₅) ₂ NCClBrCH ₃	46	224
22	Et ₂ NCl	CH ₂ =C(Cl)C(CH ₃) ₃	(C ₂ H ₅) ₂ NCH ₂ CCl ₂ C(CH ₃) ₃	80	224
23	Et ₂ NCl	CH ₂ =C(CF ₃)CH ₃	(C ₂ H ₅) ₂ NCH ₂ CCl(CF ₃)CH ₃	85	224
24	PCI ^a	CH ₂ =C(CF ₃)CH ₃	PCH ₂ CCl(CF ₃)CH ₃	88	224
25	Et ₂ NCl		(C ₂ H ₅) ₂ NCH ₂ CHClCH ₂ -Y; Y = Cl	83	224
26 ; Y = OH	48	224
27 ; Y = OAc	60	224
28 ; Y = OC ₆ H ₅	6	224
29 ; Y = C ₆ H ₅	57	224
30 ; Y = CN	84	224
31	PCI ^a	..	PCH ₂ CHClCH ₂ Y; Y = 	87	224
32 ; Y = Cl	85	224
33 ; Y = OC ₂ H ₅	88	224
34	<i>i</i> -PrNHCl		<i>i</i> -C ₃ H ₇ NHCH ₂ CHClCH ₂ Cl	56	225
35	<i>t</i> -BuNHCl		<i>t</i> -C ₄ H ₉ NHCH ₂ CHClCH ₂ Cl	70	225
36	<i>c</i> -C ₆ H ₁₁ NHCl		<i>c</i> -C ₆ H ₁₁ NHCH ₂ CHClCH ₂ Cl	52	225
37	PCI ^a	CH ₂ ClCH=CHCH ₂ Cl	CH ₂ ClCH(P)CH(Cl)CH ₂ Cl	73	224
38	<i>t</i> -BuNHCl		<i>t</i> -C ₄ H ₉ NHCH ₂ CH=CH ₂ CN	56	225
39	PCI ^a			6	224
40	PCI ^a			51	224
41	Et ₂ NCl			60	224
42	Et ₂ NCl		[(C ₂ H ₅) ₂ NCH ₂ CHClCH ₂] ₂ O	40	219

^a PCI = 

TABLE XV. Addition ^{a, b} to Acetylenes^{219,235}

Et ₂ NCl	<i>n</i> -C ₄ H ₉ C≡CH	<i>n</i> -C ₄ H ₉ CHClCHO (45) ^c	Et ₂ NCl	(CH ₃) ₃ CC≡CH	(CH ₃) ₃ CCHClCHO (60)
<i>n</i> -Bu ₂ NCl	<i>n</i> -C ₄ H ₉ C≡CH	<i>n</i> -C ₄ H ₉ CHClCHO (37)	<i>n</i> -Bu ₂ NCl	(CH ₃) ₃ CC≡CH	(CH ₃) ₃ CCHClCHO (16);
Et ₂ NCl	<i>n</i> -C ₃ H ₇ C≡CCH ₃	<i>n</i> -C ₃ H ₇ CHClCOCH ₃ (33);			(CH ₃) ₃ CCOCH ₂ Cl (5);
		<i>n</i> -C ₃ H ₇ COCHClCH ₃ (29)			(CH ₃) ₃ CCH ₂ CHO (7);
Et ₂ NCl	C ₂ H ₅ C≡CC ₂ H ₅	C ₂ H ₅ CHClCOC ₂ H ₅ (59);	PNO ^d	C ₆ H ₅ C≡CH	Phenylglyoxal ketoxime (65)
		C ₂ H ₅ CH ₂ COC ₂ H ₅ (3);	PNO ^d	C ₆ H ₅ C≡CC ₃ H ₇	Benzil monooxime (61)
		C ₂ H ₅ C≡CCHClCH ₃ (4)			
<i>n</i> -Bu ₂ NCl	C ₆ H ₅ C≡CH	C ₆ H ₅ COCH ₃ (59); C ₆ H ₅ COCH ₂ Cl (23)			

^a The chloramine additions were run in 4 M H₂SO₄-AcOH solution and the *N*-nitrosopiperidine photoadditions in 0.1 N HCl-MeOH solution. ^b The chloramine additions occurred spontaneously except that to *tert*-butyl-acetylene where photoinitiation was required. ^c Percentage yields are shown in brackets. ^d PNO = *N*-nitrosopiperidine.

TABLE XVI. Intramolecular Addition by Aminium Radicals

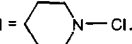
Substrate	Conditions	Product (%)	Ref
	Fe(NH ₄) ₂ (SO ₄) ₂ 4 M H ₂ SO ₄ -AcOH 25-30 °C	 (66)	240
..	TiCl ₃ -TiCl ₄ AcOH-H ₂ O	.. (65)	240
..	<i>hν</i> AcOH-H ₂ O 5 °C	.. (20)	241
..	<i>hν</i> MeOH 5 °C	 (24); (32)	241
	<i>hν</i> MeOH	 (82)	244
	TiCl ₃ AcOH-H ₂ O -10 °C	 (7.5)	239
	TiCl ₃ -TiCl ₄ AcOH-H ₂ O -15 °C	 R = Cl (77)	242
..	4 M H ₂ SO ₄ -AcOH <i>hν</i> 35 °C	.. R = OAc (40) R = Cl (20)	242
..	MeOH, <i>hν</i> -5 °C	.. R = Cl (36) R = H (11)	242
	<i>hν</i> MeOH	 X = O, (5) X = NOH, (76)	245
	<i>hν</i> , O ₂ MeOH	 Y = OH, (38) Y = ONO ₂ , (29)	246
	<i>hν</i> MeOH	 (24); (22)	244
	<i>hν</i> MeOH	 X = O, (9) X = NOH, (82)	245
	TFA, <i>hν</i>	 Cl	249
	TiCl ₃ AcOH-H ₂ O -10 °C	 (66)	243
	TiCl ₃ AcOH-H ₂ O -10 °C	 X = H, (10) X = Cl, (40)	243
		 (35)	

TABLE XVI (Continued)

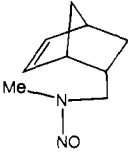
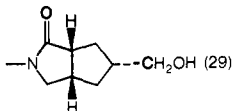
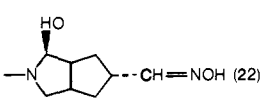
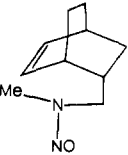
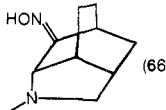
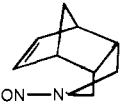
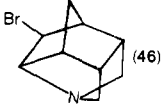
Substrate	Conditions	Product (%)	Ref	
	$h\nu$ MeOH	 (29)	 (22)	234
	$h\nu$, MeOH	 (66)		234
	$h\nu$ MeOH CBrCl ₃	 (46)		234

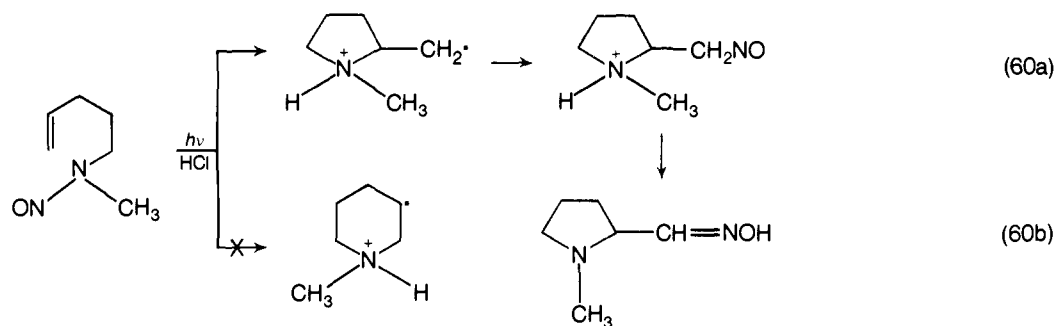

obtained in the chloramine addition²¹⁹ may arise from decomposition of the carbonyl compounds under the highly acidic conditions.

2. Intramolecular Processes

A favorable entropy term in intramolecular addition of an aminium radical to a suitably located double bond allows an efficient synthesis of pyrrolidine derivatives. Both photolysis of chloramines²³⁹⁻²⁴³ and nitrosamines²⁴⁴⁻²⁴⁶ have been used for the cyclization to give high yields of pyrrolidines; metal ion catalyzed reaction of chloramines is also an efficient cyclization process.²⁴⁰ As shown in Table XVI, except for one case (no. 14), those substrates having the double bond located at the 5-6 position always cyclize to pyrrolidine derivatives (eq 60a). The propensity to cyclize at the 5-position is characteristic of a radical reaction in which incipient bond formation is kinetically controlled and favored by a facile overlap of the relevant orbitals.^{246,248} In the cyclizations of entries 1-5 and 12, the less stable C-radical intermediates are obtained exclusively over the more stable piperidine intermediates.²⁴⁴ Furthermore, the exclusive formation of the isotwistane structure²³⁴ (no. 18) rather than the twisted structure, where the cumulative eclipsing at the bridges is at a minimum, indicates the driving forces are much larger than the eclipsing energies.

The chloramine cyclizations are sometimes complicated by the facile thermal rearrangement of 1-amino-2-chloro derivatives via aziridinium intermediates (e.g., eq 61).²⁴⁰ Such a rearrangement may serve to explain the only one anomalous six-membered ring closure observed in 1-azawistane synthesis (no. 14, eq 62).²⁴⁹ The driving force in this thermal reaction is obviously the relief of the cumulative nonbonded interactions in the isotwistane to give the staggered twistane derivative. This thermal rearrangement does not occur in 1-amino-2-nitrosoal-

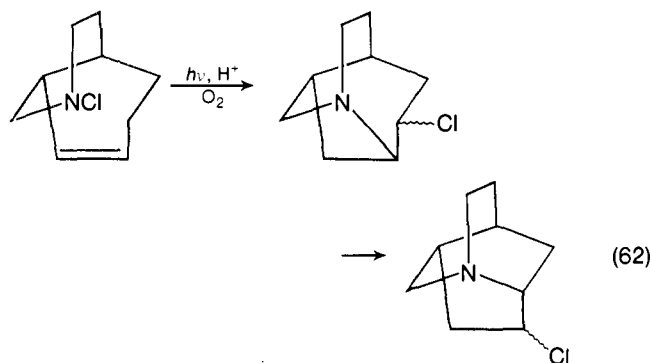
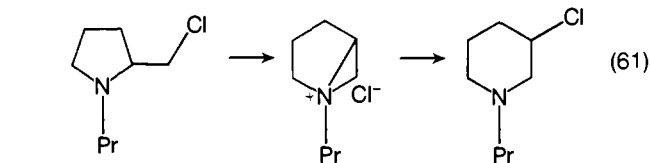

kans as shown in the nitrosamine photolysis experiments (note particularly the isotwistane synthesis no. 18).²³⁴

Finally, trapping of the C-radical intermediate in this process demonstrates the versatility of the cyclization processes (eq 63).^{240,246} It is significant that Hofmann-Löffler type products

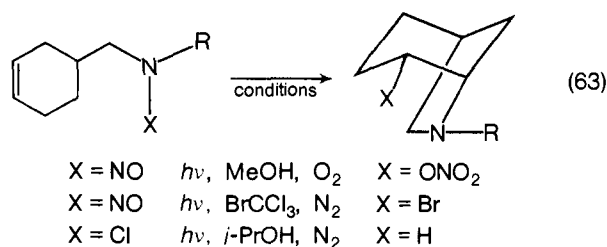

derived from allylic hydrogen abstraction have never been observed in these experiments.

It is pertinent to discuss chloramine cyclizations catalyzed by acid and silver salts which have been thought to involve nitrenium ion intermediates.²⁵⁰⁻²⁵² These reactions are somewhat controversial, and it has been argued that a radical or other mechanism^{239,253a} rather than an ionic " π -cyclization route"²⁵⁰ is involved in these processes. Recently, Edwards and co-workers^{253a} reported that silver ion does not assist the heterolysis of chloramines and a trace of silver metal in the reaction mixture may initiate radical reaction. In reply, Gassman showed that the silver ion catalyzed reaction of 3-chloro-3-azabornane gave a Wagner-Meerwein rearrangement whereas the amino radical did not.^{253b} In general, chloramine decompositions in neutral or weakly acidic solution or catalyzed with silver salt are complex owing to concurrence of various reaction routes; these examples are not included in Table XVI.

F. Aromatic Amination

Aminations of aromatic nuclei with *N*-chlorodialkylamines, *N*-chloroalkylamines, *N,N*-dichloroalkylamines, hydroxylamine, and its *O*-sulfonic acid in highly acidic media are also proposed to involve homolytic attack of aminium radicals.¹⁰ The reaction is normally initiated by a metal ion (Fe^{2+} , Ti^{3+} , Cu^+ , etc.), but scattered examples of thermally⁹⁴ and photolytically⁹³ initiated chloramine amination are also reported. Aminium radicals generated from nitrosamine photolysis in weakly acidic media do not attack benzene derivatives, apparently owing to the preferential removal of an α -hydrogen.¹¹ Since three reviews^{6,9,10} on aromatic amination by chloramines have recently appeared, readers are referred to the detailed listing of examples therein. The majority of the investigations are reported by Minisci and his co-workers, who have shown that *N*-chlorodialkylamines give highest yields.¹⁰ The following radical chain mechanisms have been proposed to account for the observed results (eq 64-67).¹⁰ Inevitably, other aminium radical processes, e.g.,

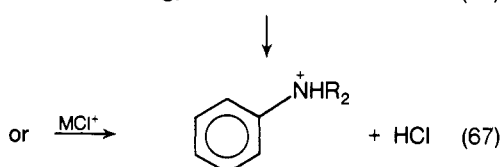
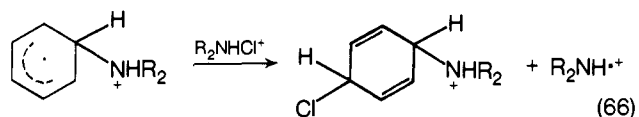
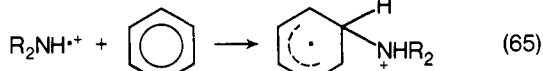

intermolecular hydrogen-chlorine exchange reactions, ionic chlorination, etc., compete against amination to give undesirable products.^{213a} In addition, the report that *N*-chlorodimethylamine decomposition in AlCl_3 -nitroalkane systems (Friedel-Crafts reaction conditions) in the presence of toluene also gives a high yield of *m*-toluidine (ortho:para:meta = 14:59:27) renders the mechanistic interpretation less certain.⁹⁵ As most of the metal salts used in the redox processes are also Lewis acids in highly acidic media, the possibility of a nitrenium pathway (eq 14) cannot be ruled out.

Support for a radical chain process is derived from the fact that the radical coupling product **34** is obtained in addition to mesitylamine (16%) in amination of mesitylene with hydroxylamines.^{76,77} That the amination possesses electrophilic character is supported by the failure to aminate benzene derivatives carrying electron-withdrawing groups (NHR_2^+ , NO_2 ,

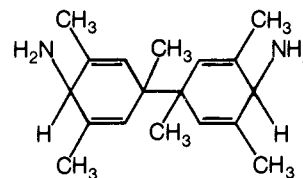

34

CO_2H , etc.)^{79,254} and by the formation of high proportions of para (90%) and ortho (4-9%) isomers, but no meta isomer, in the amination of activated aromatics (phenols and phenolic ethers).^{79,254} However, since the latter substrates are also susceptible to ionic halogenation, highly acidic media with relatively high concentrations of metal salt are necessary to promote the free radical amination.²⁵⁴ Halobenzenes are aminated in lower yields than that obtained with benzene and give mainly ortho and para isomers with <5% of the meta isomers.²⁵⁵

Interesting results are obtained by the decomposition of chloramines in the presence of certain alkylbenzenes although the observations are not readily rationalized with the proposed mechanism. With toluene as the substrate, both side-chain chlorination, via hydrogen abstraction by aminium radicals, and nuclear amination can occur.^{10,76,255,256} The products from the reaction of toluene with *N*-chlorodimethylamine vary from 95.4% nuclear amination in concentrated sulfuric acid to 100% benzylic chlorination in acetic acid.^{7,10,204} Furthermore, bulky chloramines appear to disfavor nuclear amination, attesting to the operation of steric effects.²⁰⁴ One of the striking features in the amination of alkylbenzenes is the extraordinary high percentages of meta isomers produced. Amination of toluene with *N*-chlorodimethylamine gives the identical ortho:para:meta ratio (9:53:38) regardless of whether the reaction is initiated thermally,⁹⁴ photolytically,⁹³ or by ferrous ion catalysis.⁷⁶ While these results are in agreement with the proposal that the dimethylaminium radical is the common intermediate, the variations in yield with temperature (from 5% at 10 °C to 42% at 75 °C) cannot be explained readily. Further, Cu^+ -catalyzed amination produces larger amounts of ortho and para isomers and less meta isomer than Fe^{2+} and Ti^{3+} catalyzed reactions.²⁵⁷

Amination of substituted polycyclic aromatics also occurs, in some cases with high selectivity. For example, *N*-chlorodimethylamine reacts with naphthalene²⁵⁸ to give a 68% yield of dimethylaminonaphthalenes (97% α isomer), with 1-chloronaphthalene a 98% yield of 1-chloro-*x*-dimethylaminonaphthalenes (76% 5-isomer),^{213a} and with 1-methylnaphthalene a 74% yield of 1-methyl-*x*-dimethylaminonaphthalenes (95% 4-isomer).²⁵⁸ The detailed listing of these aminations may be found in the review.¹⁰

Finally, intramolecular amination²⁵⁹ of suitably substituted phenylalkylamines allows a simple synthesis of tetrahydroquinoline and indoline (eq 68). The synthesis of the latter, however, is accompanied by extensive cleavage of the aminium radical intermediate.

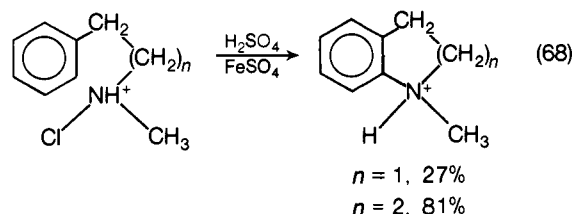

G. Other Reactions

The aminium radicals generated in photoreduction of carbonyl compounds or other substrates (section II.E) exclusively undergo α -proton transfer to give the α -radical and the ketyl radical (eq 69); addition and hydrogen abstraction typical of aminium radicals have not been demonstrated. The ensuing reactions of these

ketyl and α -radicals are further reduction of the carbonyl com-

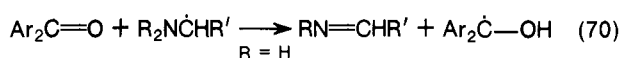
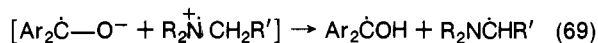

pounds (eq 70 and 71) or coupling with the intermediate radicals (eq 72).²⁸⁸ The overall reaction is the oxidation of amines to alkylidenimines balanced by reduction of carbonyl compounds to pinacols (or hydrols). Hydrolysis of alkylidenimines (or equivalents) gives the final isolated products, R_2NH and $\text{R}'\text{CHO}$.

The available results show that a less hindered α -hydrogen is preferentially transferred leading to the least substituted imine; i.e., the order of preferred elimination is that of methyl > ethyl > isopropyl groups in amines.^{107,288} It is noteworthy that photoreduction of 4-benzoylbenzoic acid by *N,N*-dimethylbenzylamine in aqueous media gives *N*-methylbenzylamine and no benzaldehyde.²⁸⁸ Photolysis of fluorenone, benzophenone, *p*-aminobenzophenone, acetophenone, and 2-naphthaldehyde in the presence of methylethylaniline gives after hydrolysis no acetaldehyde indicating demethylation as the strongly preferred process.¹⁰⁷

Typical radical coupling reactions in the photolysis of amine-carbonyl compound systems are shown below (eq 73-75).

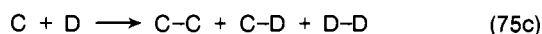
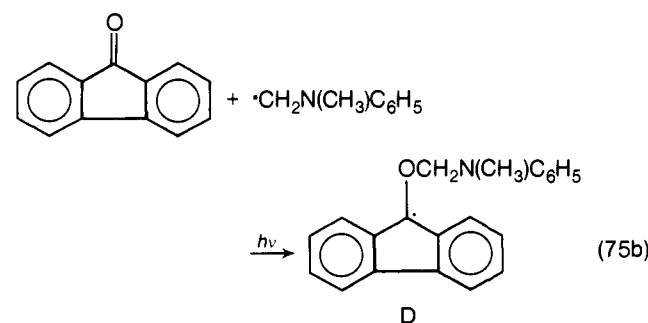
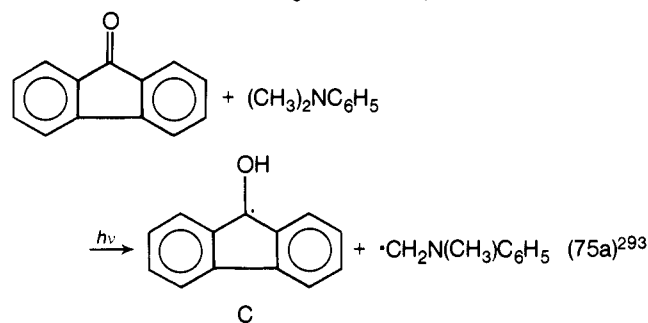
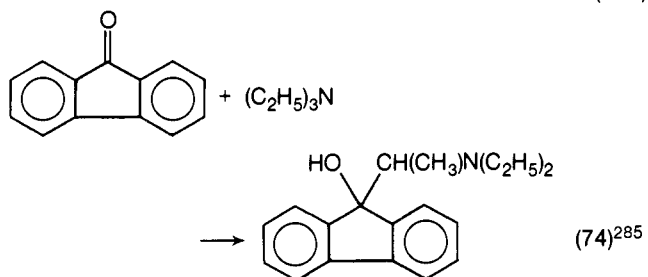
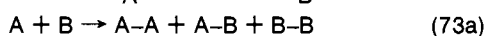
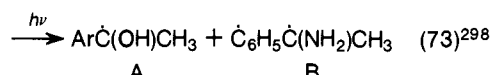
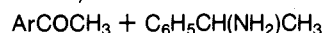

A number of intramolecular photoreductions of ketoamines are characterized by their insensitivities to triplet quenchers (e.g., dienes) and low quantum yields as opposed to high product yields. The nature of these reactions strongly supports the intermediacy of a fast intramolecular charge-transfer interaction process (eq 76-78).²⁹⁹⁻³⁰¹

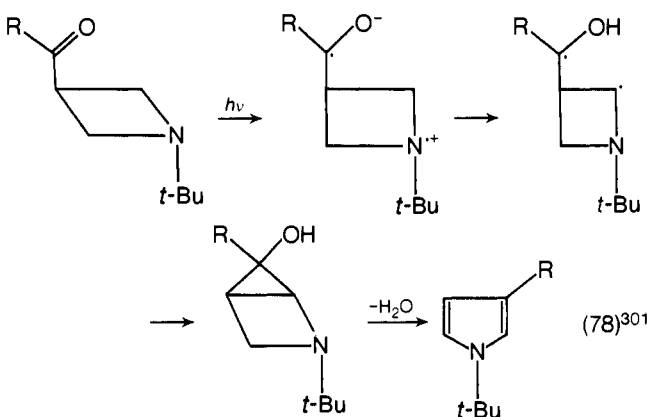
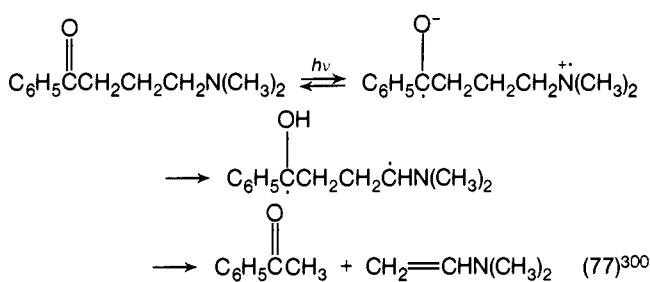
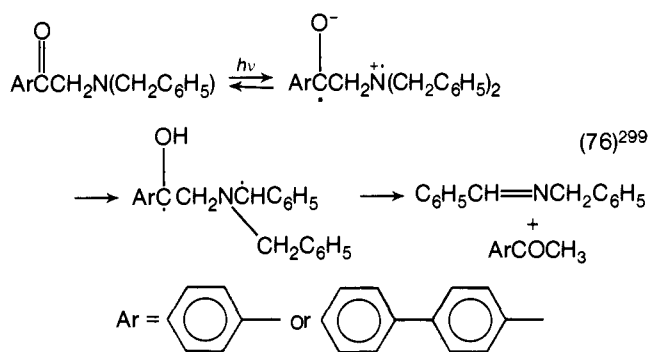

There are a few examples in which aminium radicals generated by charge-transfer interaction undertake pathways other than the α -proton transfer. Fragmentation of amino alcohols when irradiated in the presence of carbonyl and heterocyclic compounds and aromatic hydrocarbons has been suggested to occur from the radical pair in which Y^- is the anion radical derived from sensitizers (eq 79).³⁰² Photocatalyzed dechlorination³⁰³ of 4-chlorobiphenyl in the presence of triethylamine (or other amines) gives biphenyl with a chemical yield of 71% and quantum yield of 0.49 (eq 80).

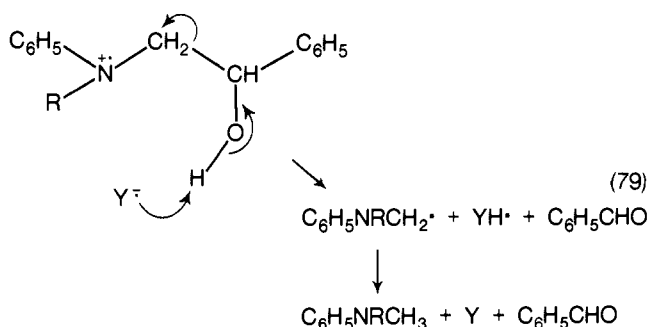

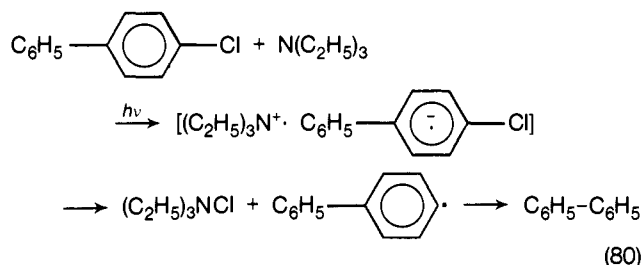

Photolysis of the stereoisomeric nitrosocholestane derivatives in acidic ethanol solution gave the spirocholane alkaloids, soladulcidine, solasodine, and tomatidine (eq 81).²⁶⁰ This was interpreted to mean that the loss of the 22-hydrogen from the corresponding aminium radical was facile to form the C=N double bond which underwent closure to the tetrahydrofuran ring by acid catalysis.

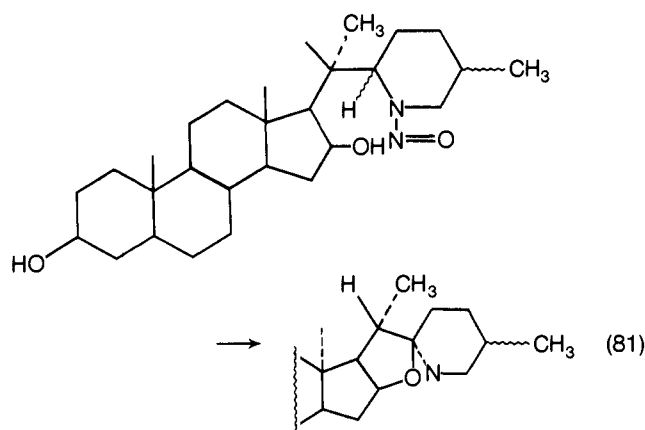

Air oxidation of dienamines derived from Δ^4 -3-keto steroids to give the conjugated endiones was suggested to be a radical chain process involving aminium radicals as the chain carriers (eq 82).²⁶¹ Since the reaction is catalyzed by cupric or ferric salt, the suggested mechanism seems to be reasonable. The Schiff bases derived from α,β -unsaturated ketones also undergo a similar reaction and probably by the same mechanism.

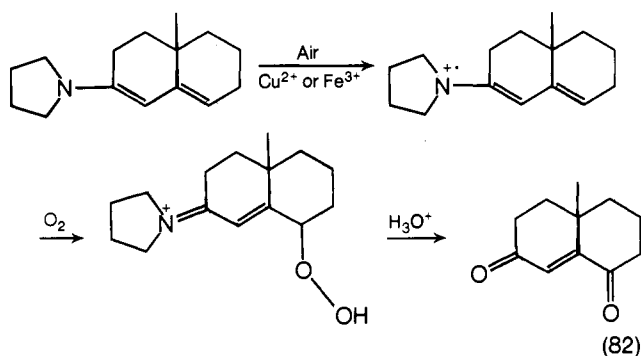

H. Reactions of Electrogenerated Nonaromatic Aminium Radicals

The reaction pathway and product produced via a transient intermediate should, in principal, be insensitive to the mode of generation of the intermediate if other experimental variables are not changed. Even though aminium radicals generated electrochemically frequently undergo reactions identical with those discussed above, there are many examples where different behavior is observed. In many instances, the electrode material is not merely a passive source or sink for electrons but becomes actively involved in the chemical processes. Hence, it is convenient to discuss the reactions of electrogenerated nonaromatic aminium radicals under the categories of "inert" and "active" electrodes.

1. "Inert" Electrodes: Platinum, Lead Dioxide, Glassy Carbon

Since protonation of amines leads to a huge increase in oxidation potential because the easily oxidized "lone-pair" electrons become involved in a covalent N-H bond, amines containing less basic functionality are "protected" from oxidation in acidic solution. Much of the early electrolytic oxidation work was done in aqueous sulfuric acid and illustrates this. The work of Takayama's group on oxidative decarboxylation of amino acids to aldehydes containing one less carbon²⁶² and the related acids has been summarized in English.²⁶³ Similarly, amino alcohols are oxidized to amino acids in 30–80% yields at lead dioxide.²⁶⁴ If other functionality is lacking, *N*-alkyl cleavage does occur, even in acid.^{263b,265}

More recent work has often been done in nonaqueous solvents. Triethylamine was found to consume 1 faraday/mole, and produce triethylammonium salts in both acetonitrile²⁶⁶ and dimethyl sulfoxide,²⁶⁷ although later work has shown that N-C cleavage also occurs. Methylamine is dehydrogenated upon electrolytic hydrogenation, and in addition to methylammonium salt, *N*-methylformaldehyde imine trimer and some dimethylformamide were isolated.²⁶⁸

In a study of several primary amine oxidations, Barnes and Mann²⁶⁹ found *n* values of 0.71 to 0.78, and, in addition to recovering about half of the starting material as the ammonium salt, isolated lower yields of NH_4^+ , nitrogen, aldehydes, or ketones derived from dehydrogenation products, and hydrocarbons. Complex mechanisms involving initial aminium radical formation, followed by either cleavage to a carbonium ion and amino radical, or deprotonation and oxidation to the ammonia-carbonyl Schiff's base were presented. Their identification of the deprotonation-oxidation pathway to Schiff's base as a "high potential" process is unfortunate, because the α -amino radicals postulated as intermediates are far easier to oxidize than the corresponding amines. Andrieux and Saveant have shown that a variety of immonium salts are reduced at quite negative potentials,²⁷⁰ and in the case of benzhydryldimethylamine, which shows an irreversible wave in acetonitrile ($E_p = 1.2$ V vs. SCE), the related immonium salt undergoes reversible reduction to dimethylaminodiphenylmethyl radical, $E^\circ = -0.88$ V (vs. SCE). Oxidation of the radical formed by C-deprotonation of an aminium radical would certainly be fast at the potential necessary for oxidation of the amine.

In further work on secondary and tertiary amine oxidations at platinum, Mann and co-workers^{271,272} found that dealkylation occurs with secondary and tertiary amines, and tried to distinguish between two pathways they envisaged for α -amino radicals giving aldehydes: disproportionation to enamine or oxidation to immonium salt, as shown in eq 83. On the basis of studies in

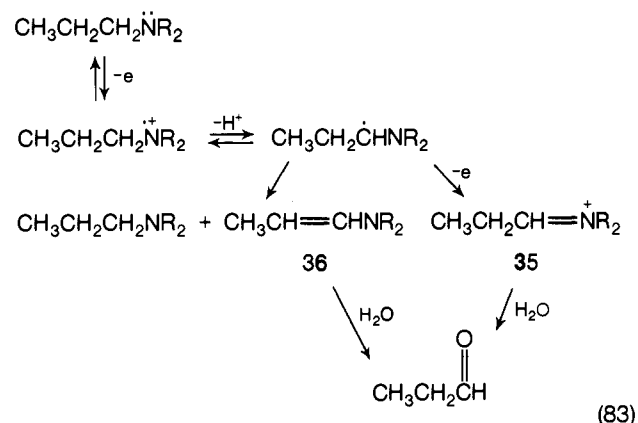

acetonitrile containing D_2O and other considerations, their argument was **35** never formed at all during the reaction, which

is obviously fallacious, since the hydrolysis of **36** proceeds by protonation to form **35**. Their conclusion that disproportionation, not electron transfer, is the pathway followed seems highly unlikely. Ross^{272b} has pointed out that hydrolysis of the immonium salt **35** would give aldehyde enol, and hence mono-deuterio aldehyde in D₂O.

The question of which alkyl group will be lost in a trialkylamine having more than one type of alkyl group has received some study. The alkyl group lost is determined by the site of deprotonation of the aminium radical, and if there were no selectivity at all, the fraction of products would be determined by the number of α -hydrogens present in the alkyl groups (which we will refer to as "statistical" product distribution). Smith and Mann²⁷¹ showed that benzyl- and allyldimethylamine cleaved the N-CH₂R bond to a greater extent than predicted statistically (25%), observing 50% of the secondary amine being dimethylamine in the former case, and only dimethylamine in the latter. They explained this on the basis of Me₂N \dot{C} HR being more stable than RCH₂N(Me) \dot{C} H₂ because of increased delocalization. When isopropyl and cyclohexyl groups are pitted against ethyl groups, however, a greater than statistical preference for N-Et cleavage was observed.^{271,272} It is not obvious that having more alkyl groups on the spin-bearing carbon would stabilize an α -amino radical, as Mann and co-workers assume, since delocalization from the lone pair on nitrogen will increase charge density at the carbon, as is shown in **37a** \leftrightarrow **37b** below; replacement of hy-

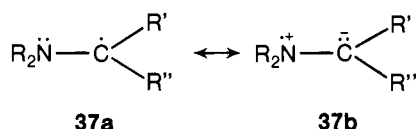

drogens for alkyl groups at R' and R'' might lead to either stabilization or destabilization. Masui and Sayo,²⁷³ in amine oxidations at pH 11.9 at glassy carbon, found that ethyl and *n*-propyl were lost in slight excess of statistical preference compared to methyl, but that Me₂N-*i*Pr cleaved almost statistically. It should be pointed out that Masui's and Mann's experiments were performed under significantly different conditions, and significant qualitative differences were observed, most notably that Mann could find no N-Me cleavage with trimethylamine, while Masui could. To further confuse matters, Weinberg and Brown²⁷⁴ found that in methanol containing potassium hydroxide, a 4:1 ratio of methyl to benzyl methoxylation was observed for benzyldimethylamine, the reverse of Smith and Mann's observation for direction of deprotonation of this compound. Although Smith and Mann²⁷⁵ disputed that an aminium radical was involved in the reaction in methanol, suggesting that methoxyl radicals were hydrogen abstracting in the reaction in basic methanol, Weinberg²⁷⁶ replied that the amine was, indeed, transferring electrons under the conditions, and restated that adsorption effects were important in determining the site of methoxylation. Several steps are involved before stable, analyzable products are formed, and it has not yet been established which steps are rate controlling, or whether kinetic or equilibrium control is most important.

2. "Active" Electrodes: Silver, Copper, Cobalt, and Nickel

Very different behavior is observed at the title electrodes in aqueous base than at the "inert" electrodes discussed above. The behavior of amines at silver electrodes is extensively discussed by Hampson, Lee, and MacDonald.²⁷⁷ A silver electrode base is oxidized to silver oxide until the oxide coating becomes about 100 monolayers deep, when current flow ceases. Addition of various compounds, including amines, results in consumption of the silver oxide layer, allowing oxidation to proceed. The products formed from primary amines include nitriles and al-

dehydes from RNH₂ (R = primary), and alcohols, nitro compounds, and olefins from RNH₂ (R = tertiary).^{277,278} Secondary amines react far more slowly, although similar *N*-alkyl cleavage products are formed.²⁷⁹ Tertiary amines appear not to be oxidized. It is concluded that amines complex with electrochemically generated silver oxides, and subsequently react. Only adsorbed amine reacts, causing substantial rate effects. Fleishmann, Korinek, and Pletcher²⁸⁰ have shown that similar reactions occur at all of the title electrodes, and convincingly argue that the electrolytic reaction is oxidation of the metal oxides to an upper oxidation level (Ag^I \rightarrow Ag^{II}, Cu^I \rightarrow Cu^{II}, Co^I \rightarrow Co^{II}, Ni^I \rightarrow Ni^{II}), and that organic compounds react with the higher oxide. This conclusion is supported by the fact that amines and alcohols which are oxidized all proceed at the same potential at each metal oxide (the potential for oxidation to the higher charge), and that the re-reduction of the higher oxide can be observed at sufficiently high scan rates. A primary isotope effect was observed in a comparison of the rates of oxidation for CD₃OH and CH₃OH, implying a rate-limiting proton or hydrogen atom transfer from the carbon electrode. The generalization of this result to amines merits further study. The relative rates for amine oxidations at the various metal oxide coated electrodes were Cu > Ni > Ag > Co, although a different qualitative ordering was observed for alcohols. Fleischmann and co-workers also noted that iron and gold electrodes show similar reactions, although at slower rates.

Acknowledgments. Y. L. Chow acknowledges the National Research Council of Canada, W. C. Danen the donors of the Petroleum Research Fund, administered by the American Chemical Society, and S. F. Nelsen the National Science Foundation for support during the writing of this review.

V. References and Notes

- (1) S. Wawzonek and P. J. Thelen, *J. Am. Chem. Soc.*, **72**, 2118 (1950).
- (2) L. Horner, *Angew. Chem.*, **62**, 359 (1950).
- (3) (a) T. Cole, *J. Chem. Phys.*, **35**, 1169 (1961); (b) J. S. Hyde and E. S. Freeman, *J. Phys. Chem.*, **65**, 1636 (1961).
- (4) A. J. Tench, *J. Chem. Phys.*, **38**, 593 (1963).
- (5) M. E. Wolff, *Chem. Rev.*, **63**, 55 (1963).
- (6) P. Kovacic, M. K. Lowery, and K. W. Field, *Chem. Rev.*, **70**, 639 (1970).
- (7) R. S. Neale, *Synthesis*, **1** (1971).
- (8) N. C. Deno in "Methods in Free Radical Chemistry", Vol. 3, E. S. Huyser, Ed., Marcel-Dekker, New York, N.Y., 1972, pp 135-154.
- (9) G. Sosnovsky and D. J. Rawlinson in "Advances in Free-Radical Chemistry", Vol. IV, G. H. Williams, Ed., Logos Press, London, 1972, pp 203-284.
- (10) F. Minisci, *Synthesis*, **1** (1973).
- (11) Y. L. Chow, *Acc. Chem. Res.*, **6**, 354 (1973).
- (12) S. F. Nelsen in "Free Radicals", Vol. II, J. K. Kochi, Ed., Wiley, New York, N.Y., 1973, pp 527-593.
- (13) E. Müller, Ed., "Houben-Weyl's Methods of Organic Chemistry", Vol. XI/2, Georg Thieme Publishing Co., Stuttgart, Germany, 1958, pp 190-200.
- (14) P. S. Bailey, J. E. Keller, D. A. Mitchard, and H. M. White, *Adv. Chem. Ser.*, No. 77, 58-64 (1968).
- (15) N. J. Leonard and D. F. Morrow, *J. Am. Chem. Soc.*, **80**, 371 (1958); N. J. Leonard, A. S. Hay, R. W. Fulmer, and V. W. Gash, *ibid.*, **77**, 439 (1955); N. J. Leonard and R. R. Sauer, *ibid.*, **79**, 6210 (1957); N. J. Leonard, W. J. Middleton, P. D. Thomas, and D. Choudhury, *J. Org. Chem.*, **21**, 344 (1956).
- (16) M. Wei and R. Stewart, *J. Am. Chem. Soc.*, **88**, 1974 (1966).
- (17) H. A. Hageman in "Organic Reactions", Vol. VII, R. Adams, Ed., Wiley, New York, N.Y., 1953, pp 198-262.
- (18) N. C. Deno and R. E. Fruit, Jr., *J. Am. Chem. Soc.*, **90**, 3502 (1968); D. G. Lee and R. Srinivasan, *Can. J. Chem.*, **51**, 2546 (1973).
- (19) P. A. S. Smith and R. N. Loeppky, *J. Am. Chem. Soc.*, **89**, 1147 (1967).
- (20) (a) G. M. Coppinger and J. D. Swalen, *J. Am. Chem. Soc.*, **83**, 4900 (1961); (b) H. E. DeLaMare, *J. Org. Chem.*, **25**, 2114 (1960).
- (21) N. J. Leonard and M. A. Rebenstorf, *J. Am. Chem. Soc.*, **67**, 49 (1945).
- (22) C. F. Cullis and D. J. Waddington, *Proc. R. Soc. London, Ser. A*, **244**, 110 (1958); **246**, 91 (1958).
- (23) H. B. Henbest and M. J. W. Stratford, *Chem. Ind. (London)*, 1170 (1961).
- (24) J. K. Kochi and E. A. Singleton, *Tetrahedron*, **24**, 4649 (1968).
- (25) R. M. Akopyan, N. M. Beileryan, O. A. Chaltikyan, and G. D. Akopyan, *Arm. Khim. Zh.*, **25**, 644 (1972); R. O. Chaltikyan and N. M. Beileryan, *ibid.*, **26**, 531 (1973).

- (26) (a) C. A. Audeh and J. R. Lindsay Smith, *J. Chem. Soc. B*, 1280 (1970); (b) *ibid.*, 1741 (1971); (c) *ibid.*, 1745 (1971).
- (27) R. L. Huang, *J. Chem. Soc.*, 1816 (1959); this treatment of α -coupling was foreshadowed, without any discussion of mechanism, by J. H. Raley and F. H. Seubold, U.S. Patent 2,537,857 (Jan 9, 1951); *Chem. Abstr.*, **45**, 3414 (1951).
- (28) H. B. Henbest and R. Patton, *J. Chem. Soc.*, 3557 (1960).
- (29) J. R. Lindsay Smith and L. A. V. Mead, *J. Chem. Soc., Perkin Trans. 2*, 206 (1973).
- (30) J. R. Lindsay Smith and L. A. V. Mead, *J. Chem. Soc. Perkin Trans. 2*, 1172 (1976).
- (31) K. S. Shukla, P. C. Mathur, and O. P. Bansal, *J. Inorg. Nucl. Chem.*, **35**, 1301 (1973).
- (32) L. A. Hull, G. T. Davis, and D. H. Rosenblatt, *J. Am. Chem. Soc.*, **91**, 6247 (1969).
- (33) D. H. Rosenblatt, G. T. Davis, L. A. Hull, and G. D. Forberg, *J. Org. Chem.*, **33**, 1649 (1968).
- (34) D. H. Rosenblatt, A. J. Hayes, Jr., B. L. Harrison, R. A. Streaty, and K. A. Moore, *J. Org. Chem.*, **28**, 2790 (1963).
- (35) D. H. Rosenblatt, L. A. Hull, D. C. DeLuca, G. T. Davis, R. C. Weglein, and H. K. R. Williams, *J. Am. Chem. Soc.*, **89**, 1158 (1967).
- (36) L. A. Hull, G. T. Davis, D. H. Rosenblatt, H. K. R. Williams, and R. C. Weglein, *J. Am. Chem. Soc.*, **89**, 1163 (1967).
- (37) W. H. Dennis, Jr., L. A. Hull, and D. H. Rosenblatt, *J. Org. Chem.*, **32**, 3783 (1967).
- (38) L. A. Hull, G. T. Davis, D. H. Rosenblatt, and C. K. Mann, *J. Phys. Chem.*, **73**, 2142 (1969).
- (39) L. A. Hull, W. P. Giordano, D. H. Rosenblatt, G. T. Davis, C. K. Mann, and S. B. Milliken, *J. Phys. Chem.*, **73**, 2147 (1969).
- (40) G. T. Davis, M. M. Demek, and D. H. Rosenblatt, *J. Am. Chem. Soc.*, **94**, 3321 (1972).
- (41) G. Gordon, R. G. Kieffer, and D. H. Rosenblatt, *Prog. Inorg. Chem.*, **15**, 201 (1972).
- (42) H. J. Dauben, Jr., and L. L. McCoy, *J. Am. Chem. Soc.*, **81**, 4863 (1959).
- (43) J. R. Lindsay Smith and J. S. Sadd, *J. Chem. Soc., Perkin Trans. 2*, 741 (1976).
- (44) S. K. Malhotra, J. J. Hostynek, and A. F. Lundin, *J. Am. Chem. Soc.*, **90**, 6565 (1968).
- (45) H. Weingarten and J. S. Wager, *J. Org. Chem.*, **35**, 1750 (1970).
- (46) L. Horner and F. Hübner, *Justus Liebig's Ann. Chem.*, **579**, 193 (1953).
- (47) L. Horner and C. Betzel, *Justus Liebig's Ann. Chem.*, **579**, 175 (1953).
- (48) H. Böhme and W. Krause, *Angew. Chem.*, **63**, 531 (1951).
- (49) A. J. Ellis and F. G. Soper, *J. Chem. Soc.*, 1750 (1954).
- (50) L. Horner and G. Podschus, *Angew. Chem.*, **63**, 531 (1951).
- (51) D. H. Rosenblatt, M. M. Demek, and G. T. Davis, *J. Org. Chem.*, **37**, 4148 (1972).
- (52) D. H. Rosenblatt and G. T. Davis, "Laboratory Course in Organic Chemistry", 2nd ed, Allyn and Bacon, Inc., Boston, Mass., 1973, pp 388-404.
- (53) T. Higuchi, A. Hussain, and I. H. Pittman, *J. Chem. Soc. B*, 626 (1969).
- (54) L. Horner and W. Kirmse, *Justus Liebig's Ann. Chem.*, **597**, 48 (1955).
- (55) C. Walling, "Free Radicals in Solution", Wiley, New York, N.Y., 1957, pp 590-593.
- (56) C. C. Sweeley and E. C. Horning, *J. Am. Chem. Soc.*, **79**, 2620 (1957).
- (57) J. C. Craig, F. P. Dwyer, A. Y. Clazer, and E. C. Horning, *J. Am. Chem. Soc.*, **83**, 1871 (1961).
- (58) J. C. Craig, N. Y. Mary, and L. Wolf, *J. Org. Chem.*, **29**, 2868 (1964).
- (59) J. C. Craig, N. Y. Mary, N. L. Goldman, and L. Wolf, *J. Am. Chem. Soc.*, **86**, 3866 (1964).
- (60) S. Ghosal and B. Mukherjee, *J. Org. Chem.*, **31**, 2284 (1966).
- (61) J. P. Ferris, and R. D. Gerwe, *Tetrahedron Lett.*, 1613 (1964).
- (62) J. P. Ferris, R. D. Gerwe, and G. R. Gapski, *J. Am. Chem. Soc.*, **89**, 5270 (1967); *J. Org. Chem.*, **33**, 3493 (1968).
- (63) N. C. Deno and D. G. Pohl, *J. Am. Chem. Soc.*, **96**, 6680 (1974).
- (64) L. Horner and H. Junkermann, *Justus Liebig's Ann. Chem.*, **591**, 53 (1955).
- (65) L. Horner and H. Brüggemann, *ibid.*, **635**, 22 (1960).
- (66) N. C. Deno, K. Eisenhardt, R. Fishbein, C. Pierson, D. Pohl, H. Spinelli, R. C. White, and J. C. Wyckoff, *Proc. Int. Congr. Pure Appl. Chem.*, **4**, 155 (1972).
- (67) P. Davis, M. G. Evans, and W. C. E. Higginson, *J. Chem. Soc.*, 2563 (1951).
- (68) C. J. Albisetti, D. D. Coffman, F. W. Hoover, E. J. Jenner, and W. E. Mochel, *J. Am. Chem. Soc.*, **81**, 1489 (1959).
- (69) H. Seaman, P. J. Taylor, and W. A. Waters, *J. Chem. Soc.*, 4690 (1954).
- (70) E. Howard, U.S. Patent 2,683,140, (July 6, 1954); U.S. Patent 2,567,109 (Sept 4, 1951).
- (71) E. J. Corey and W. R. Hertler, *J. Am. Chem. Soc.*, **82**, 1657 (1960).
- (72) R. W. Lockhart, R. W. Snyder, and Y. L. Chow, *J. Chem. Soc., Chem. Commun.*, 52 (1976).
- (73) H. Richard and Y. L. Chow, unpublished results.
- (74) S. F. Nelsen, R. B. Metzler, and M. Iwamura, *J. Am. Chem. Soc.*, **91**, 5103 (1969).
- (75) F. Minisci and R. Galli, *Tetrahedron Lett.*, 1679 (1965).
- (76) F. Minisci, R. Galli, and M. Cecere, *Tetrahedron Lett.*, 4663 (1965).
- (77) F. Minisci, R. Galli, M. Cecere, and R. Mondelli, *Chim. Ind. (Milan)*, **47**, 994 (1965).
- (78) F. Minisci, R. Galli, and M. Cecere, *Tetrahedron Lett.*, 3163 (1966), and references cited therein.
- (79) F. Minisci, R. Galli, and G. Polina, *Chim. Ind. (Milan)*, **47**, 736 (1965).
- (80) F. Minisci and R. Galli, *Chim. Ind. (Milan)*, **46**, 546 (1964).
- (81) F. Minisci, R. Galli, and M. Cecere, *Chim. Ind. (Milan)*, **48**, 132, 347 (1966).
- (82) S. Shih, R. J. Bunker, S. D. Peyerlshoff, and C. J. Michejda, *J. Am. Chem. Soc.*, **94**, 7620 (1972).
- (83) C. J. Michejda and D. H. Campbell, *J. Am. Chem. Soc.*, **96**, 929 (1974).
- (83a) V. W. Day, D. H. Campbell, and C. J. Michejda, *J. Chem. Soc., Chem. Commun.*, 118 (1975).
- (84) For a review of early work, see N. L. Weinberg and H. R. Weinberg, *Chem. Rev.*, **68**, 449 (1968).
- (85) C. K. Mann and K. K. Barnes, "Electrochemical Reactions in Non-Aqueous Systems", Marcel Dekker, New York, N.Y., 1970.
- (86) L. C. Portis, V. V. Bhat, and C. J. Mann, *J. Org. Chem.*, **35**, 2175 (1970).
- (87) B. L. Laube, M. R. Asirvatham, and C. K. Mann, *J. Org. Chem.*, **42**, 670 (1977).
- (88) C. J. Michejda and D. Romans, *Tetrahedron Lett.*, 4213 (1969).
- (89) S. Wawzonek, M. F. Nelson, Jr., and P. J. Thelen, *J. Am. Chem. Soc.*, **73**, 2806 (1951).
- (90) J. Spanswick and K. U. Ingold, *Can. J. Chem.*, **48**, 546, 554 (1970).
- (91) N. C. Deno, W. E. Billups, R. Fishbein, C. Pierson, R. Whalen, and J. C. Wyckoff, *J. Am. Chem. Soc.*, **93**, 438 (1971).
- (92) R. S. Neale and M. R. Walsh, *J. Am. Chem. Soc.*, **87**, 1255 (1965).
- (93) H. Bock and K. Kompa, *Chem. Ber.*, **99**, 1357 (1966).
- (94) H. Bock and K. Kompa, *Chem. Ber.*, **99**, 1347 (1966).
- (95) H. Bock and K. Kompa, *Chem. Ber.*, **99**, 1361 (1966).
- (96) G. S. Hammond, B. Seidel, and R. E. Pincock, *J. Org. Chem.*, **28**, 3275 (1963).
- (97) Y. L. Chow, *Can. J. Chem.*, **45**, 53 (1967).
- (98) Y. L. Chow and C. J. Colon, *Can. J. Chem.*, **46**, 2827 (1968); Y. L. Chow, C. J. Colon, and J. N. S. Tam, *ibid.*, **46**, 2821 (1968).
- (99) M. P. Lau, A. J. Cessna, Y. L. Chow, and R. W. Yip, *J. Am. Chem. Soc.*, **93**, 3808 (1971).
- (100) A. J. Cessna, S. E. Sugamori, R. W. Yip, M. P. Lau, R. S. Snyder, and Y. L. Chow, *J. Am. Chem. Soc.*, **99**, 4044 (1977), and unpublished results.
- (101) P. N. Magee, "Topics in Chemical Carcinogenesis", W. Nakahara, S. Takayama, T. Sugimura and O. Odashima, Ed., University of Tokyo Press, Tokyo, 1972, p 259.
- (102) M. Simic and E. Hayon, *J. Am. Chem. Soc.*, **93**, 5982 (1971).
- (103) R. W. Fessenden and P. Neta, *J. Phys. Chem.*, **76**, 2857 (1972).
- (104) P. Neta and R. W. Fessenden, *J. Phys. Chem.*, **75**, 738 (1971), and references therein.
- (105) T. Henriksen, T. B. Melo, and G. Saxeol in "Free Radicals in Biology", Vol. 2, W. A. Pryor, Ed., Academic Press, New York, N.Y., 1976, p 213.
- (106) H. Budzikiewicz, C. Djerassi, and D. H. Williams, "Mass Spectrometry of Organic Compounds", Holden-Day, San Francisco, Calif., 1967, p 297.
- (107) S. G. Cohen, A. Parola, and G. H. Parsons, Jr., *Chem. Rev.*, **73**, 141 (1973).
- (108) H. Knibbe, D. Rehm, and A. Weller, *Ber. Bunsenges. Phys. Chem.*, **72**, 257 (1968).
- (109) H. Knibbe, D. Rehm, and A. Weller, *Ber. Bunsenges. Phys. Chem.*, **73**, 834, 839 (1969).
- (110) R. S. Davidsson and M. Santhanam, *J. Chem. Soc. Perkin Trans. 2*, 2355 (1972).
- (111) H. D. Roth and A. A. Lamola, *J. Am. Chem. Soc.*, **96**, 6270 (1974).
- (112) For textbook discussion of cyclic voltammetry, see G. Cauquis and V. D. Parker in "Organic Electrochemistry", M. M. Baizer, Ed., Marcel Dekker, New York, N.Y., 1973, p 115; A. J. Fry, "Synthetic Organic Electrochemistry", Harper & Row, New York, N.Y., 1973.
- (113) R. S. Nicholson and I. Shain, *Anal. Chem.*, **36**, 706 (1964).
- (114) D. H. Evans, *J. Phys. Chem.*, **76**, 1160 (1972).
- (115) S. F. Nelsen, R. Gschwind, E. Haselbach, and S. Lanoyiova, to be published.
- (116) G. K. Mann, *Anal. Chem.*, **36**, 2424 (1964).
- (117) C. K. Mann and K. K. Barnes, "Electrochemical Reactions in Nonaqueous Systems", Marcel Dekker, New York, N.Y., 1970, p 279.
- (118) M. Masui, H. Sayo, and Y. Tsuda, *J. Chem. Soc. B*, 973 (1968).
- (119) J. R. Lindsay Smith and D. Masheder, *J. Chem. Soc., Perkin Trans. 2*, 47 (1976).
- (120) L. L. Miller, G. D. Nordblom, and E. A. Mayeda, *J. Org. Chem.*, **37**, 916 (1972).
- (121) J. C. Coll, D. R. Crist, M. G. Barrio, and N. J. Leonard, *J. Am. Chem. Soc.*, **94**, 7092 (1972).
- (122) J. M. Fritsch, H. Weingarten, and J. D. Wilson, *J. Am. Chem. Soc.*, **92**, 4038 (1970).
- (123) K. Kuwata and D. H. Geske, *J. Am. Chem. Soc.*, **86**, 2101 (1964).
- (124) F. McCapra, *Q. Rev. Chem. Soc.*, **20**, 485 (1966).
- (125) C. A. Heller, *Adv. Chem.*, **75**, 255 (1967).
- (126) S. F. Nelsen and P. J. Hintz, *J. Am. Chem. Soc.*, **94**, 7114 (1972).
- (127) T. M. McKinney and D. H. Geske, *J. Am. Chem. Soc.*, **87**, 3013 (1965).
- (128) G. W. Eastland and M. C. R. Symons, *Chem. Phys. Lett.*, **45**, 422 (1977).
- (129) (a) R. Hoffmann, A. Imamura, and W. J. Hehre, *J. Am. Chem. Soc.*, **90**, 1499 (1968); (b) R. Hoffmann, *Acc. Chem. Res.*, **4**, 1 (1971); (c) M. J. S. Dewar and J. S. Wasson, *J. Am. Chem. Soc.*, **92**, 3506 (1970).
- (130) (a) P. A. Bischoff, J. A. Hasmall, E. Heilbronner, and V. Hornung, *Tetrahedron Lett.*, 4025 (1969); (b) E. Heilbronner and K. A. Muszkat, *J. Am. Chem. Soc.*, **92**, 3878 (1970).
- (131) R. H. Staley and J. L. Beauchamp, *J. Am. Chem. Soc.*, **96**, 1604 (1974).
- (132) S. F. Nelsen and J. M. Buschek, *J. Am. Chem. Soc.*, **96**, 6424 (1974).
- (133) S. F. Nelsen and C. R. Kessel, *J. Chem. Soc., Chem. Commun.*, 490 (1977).
- (134) R. W. Alder, R. Gill, and N. C. Goode, *J. Chem. Soc., Chem. Commun.*, 973 (1976).

- (135) R. W. Alder, N. C. Goode, T. J. King, J. M. Mellow, and B. W. Miller, *J. Chem. Soc., Chem. Commun.*, 173 (1976).
- (136) For a discussion of ionization potentials and their measurement, see D. W. Turner, *Adv. Phys. Org. Chem.*, 4, 31 (1966).
- (137) D. W. Turner, C. Baker, A. D. Baker, and C. R. Brundle, "Molecular Photoelectron Spectroscopy", Wiley, New York, N.Y., 1970.
- (138) D. H. Aue, H. M. Webb, and M. T. Bowers, *J. Am. Chem. Soc.*, 97, 4436 (1975).
- (139) (a) M. I. Al-Jobory and D. W. Turner, *J. Chem. Soc.*, 4434 (1964); (b) N. Bodor, M. J. S. Dewar, W. B. Jennings, and S. D. Worley, *Tetrahedron*, 26, 4109 (1970).
- (140) K. Watanabe and J. R. Mottl, *J. Chem. Phys.*, 26, 1773 (1957).
- (141) (a) K. Yashikawa, M. Hashimoto, and I. Morishima, *J. Am. Chem. Soc.*, 96, 288 (1974); (b) I. Morishima, K. Yoshikawa, M. Hashimoto, and K. Bekki, *ibid.*, 97, 4285 (1975).
- (142) D. H. Aue, H. M. Webb, and M. I. Bowers, *J. Am. Chem. Soc.*, 98, 311 (1976).
- (143) T. Sasaki, S. Eguchi, T. Kiriya, and Y. Sakito, *J. Chem. Soc., Chem. Commun.*, 725 (1974).
- (144) S. F. Nelsen and J. M. Buscheck, *J. Am. Chem. Soc.*, 96, 7930 (1974).
- (145) S. Leavell, J. Steicher, and J. L. Franklin, *J. Chem. Phys.*, 59, 4343 (1973).
- (146) N. M. Beileryan, *Uch. Zap., Erevan. Univ., Estestv. Nauk*, 128 (1971); *Chem. Abstr.*, 78, 146916k (1973).
- (147) L. G. Melik-Ogandzhanyan, R. O. Chaltkyan, and N. M. Beileryan, *Uch. Zap., Erevan. Univ. Estestv. Nauk*, 122 (1971); *Chem. Abstr.*, 78, 71085c (1973).
- (148) R. O. Chaltkyan and N. M. Beileryan, *Arm. Khim. Zh.*, 26, 625 (1973); *Chem. Abstr.*, 79, 145677s (1973).
- (149) S. F. Nelsen and R. T. Landis, *J. Am. Chem. Soc.*, 96, 1788 (1974).
- (150) L. Echevoyen and S. F. Nelsen, unpublished results.
- (151) J. E. Wertz and J. R. Bolton, "Electron Spin Resonance", McGraw-Hill, New York, N.Y., Table C (inside back cover), 1972.
- (152) (a) L. Pauling, *J. Chem. Phys.*, 51, 2767 (1969); (b) H. Bent, *Chem. Rev.*, 61, 275 (1961).
- (153) (a) R. C. Bingham and M. J. S. Dewar, *J. Am. Chem. Soc.*, 95, 7182 (1973); (b) P. J. Krusic and R. C. Bingham, *ibid.*, 98, 230 (1976).
- (154) R. W. Fessenden, *J. Phys. Chem.*, 71, 74 (1967).
- (155) R. W. Fessenden and R. H. Schuler, *J. Chem. Phys.*, 43, 2704 (1965).
- (156) A. J. Dobbs, B. C. Gilbert, and R. O. C. Norman, *J. Chem. Soc. A*, 124 (1971).
- (157) P. J. Krusic, T. A. Rettig, and P. v. R. Schleyer, *J. Am. Chem. Soc.*, 94, 995 (1972).
- (158) S. P. Mishra and M. C. R. Symons, *Tetrahedron Lett.*, 2267 (1973).
- (159) See, for example, L. Kaplan in "Free Radicals" Vol. 2, J. K. Kochi, Ed., Wiley-Interscience, New York, N.Y., 1973, p 361.
- (160) J. A. Pople, D. L. Beveridge, and P. A. Dobosh, *J. Am. Chem. Soc.*, 90, 4201 (1968).
- (161) W. C. Danen, unpublished results.
- (162) M. Fujimoto and J. R. Morton, *Can. J. Chem.*, 43, 1012 (1965).
- (163) G. Giacometti and P. L. Nordio, *Mol. Phys.*, 6, 301 (1963).
- (164) K. V. S. Rao and M. C. R. Symons, *J. Chem. Soc. A*, 2163 (1971).
- (165) K. F. Purcell and W. C. Danen, *J. Am. Chem. Soc.*, 94, 7613 (1972).
- (166) D. E. Wood, L. F. Williams, R. F. Sprecher, and W. A. Lathan, *J. Am. Chem. Soc.*, 94, 6241 (1972).
- (167) M. C. R. Symons, *Tetrahedron Lett.*, 207 (1973).
- (168) J. B. Lisle, L. F. Williams, and D. E. Wood, *J. Am. Chem. Soc.*, 98, 227 (1976).
- (169) P. J. Krusic and P. Meakin, *J. Am. Chem. Soc.*, 98, 228 (1976).
- (170) T. Koenig, T. Balle, and W. Snell, *J. Am. Chem. Soc.*, 97, 662 (1975).
- (171) W. C. Danen and R. C. Rickard, *J. Am. Chem. Soc.*, 94, 3254 (1972).
- (172) J. R. Rowlands and D. H. Whiffen, *Nature (London)*, 193, 61 (1962).
- (173) W. C. Danen and R. C. Rickard, *J. Am. Chem. Soc.*, 97, 2303 (1975).
- (174) W. C. Danen and T. T. Kensler, *J. Am. Chem. Soc.*, 92, 5235 (1970).
- (175) F. A. Neugebauer and S. Bamberger, *Angew. Chem., Int. Ed. Engl.*, 10, 71 (1971).
- (176) (a) C. B. Colburn, R. Ettinger, and F. A. Johnson, *Inorg. Chem.*, 3, 455 (1964); (b) S. F. Nelsen, G. R. Weisman, P. J. Hintz, D. Olp, and M. R. Fahey, *J. Am. Chem. Soc.*, 96, 2916 (1974).
- (177) Y. Ellinger, R. Subra, A. Rassat, J. Douady, and G. Berthier, *J. Am. Chem. Soc.*, 97, 476 (1975).
- (178) J. A. Brivati, K. D. J. Root, M. C. R. Symons, and D. J. A. Tinling, *J. Chem. Soc. A*, 1942 (1969).
- (179) L. Magdzinsky, unpublished results.
- (180) M. C. R. Symons, *Nature (London)*, 224, 686 (1969); T. A. Claxton, *ibid.*, 226, 1242 (1970).
- (181) For a discussion see H. Fischer in ref 159, p 446.
- (182) R. W. Fessenden and R. H. Schuler, *J. Chem. Phys.*, 39, 2147 (1973).
- (183) J. R. Bolton, A. Carrington, and A. D. McLachlan, *Mol. Phys.*, 5, 31 (1962).
- (184) G. R. Underwood and V. L. Vogel, *J. Chem. Phys.*, 51, 4323 (1969).
- (185) (a) G. A. Russell and K. Y. Chang, *J. Am. Chem. Soc.*, 87, 4381 (1965); (b) G. A. Russell, K. Y. Chang, and C. W. Hefford, *ibid.*, 87, 4383 (1965); (c) G. A. Russell, J. J. McDonnell, P. R. Whittle, R. S. Givens, and R. G. Keske, *ibid.*, 93, 1452 (1971).
- (186) T. A. Claxton and N. A. Smith, *Trans. Faraday Soc.*, 66, 1825 (1970).
- (187) (a) W. A. Lathan, W. J. Hehre, L. A. Curtis, and J. A. Pople, *J. Am. Chem. Soc.*, 93, 6377 (1971); (b) S. F. Nelsen and C. R. Kessel, *ibid.*, 99, 2392 (1977).
- (188) S. F. Nelsen, unpublished results.
- (189) E. J. Land and G. Porter, *Trans. Faraday Soc.*, 59, 2027 (1963).
- (190) V. Malatesta and K. U. Ingold, *J. Am. Chem. Soc.*, 95, 6400 (1973).
- (191) J. R. Lindsay Smith, R. O. C. Norman, and A. G. Rowley, *J. Chem. Soc., Perkin Trans. 1*, 228 (1972).
- (192) G. T. Davis, D. H. Rosenblatt, and M. M. Demek, unpublished results.
- (193) J. R. Lindsay Smith, unpublished results.
- (194) E. Schmitz and D. Murawski, *Chem. Ber.*, 99, 1493 (1966).
- (195) (a) Y. L. Chow, M. P. Lau, R. A. Perry, and J. N. S. Tam, *Can. J. Chem.*, 50, 1044 (1972); (b) R. S. Neale, M. R. Walsh, and N. L. Marcus, *J. Org. Chem.*, 30, 3683 (1965).
- (196) F. Minisci, R. Galli, and M. A. Rossetti, *Chim. Ind. (Milan)*, 49, 947 (1972).
- (197) R. Tadayoni, J. Lacrampe, A. Heumann, R. Furstoss, and B. Waegell, *Tetrahedron Lett.*, 735 (1975).
- (198) R. Furstoss, P. Teissier and B. Waegell, *Tetrahedron Lett.*, 1263 (1970); G. Esposito, R. Furstoss, and B. Waegell, *ibid.*, 895 (1971).
- (199) G. Esposito, R. Furstoss, and B. Waegell, *Tetrahedron Lett.*, 899 (1971).
- (200) K. Löffler and S. Kober, *Chem. Ber.*, 42, 3431 (1909).
- (201) J. F. Kerwin, M. E. Wolff, F. F. Owings, B. B. Lewis, B. Blank, A. Magnani, C. Karash, and V. Georgian, *J. Org. Chem.*, 27, 3628 (1962).
- (202) M. Uskokovic, C. Reese, H. L. Lee, G. Grethe, and J. Gutzwiller, *J. Am. Chem. Soc.*, 93, 5902 (1971).
- (203) F. Minisci, R. Galli, R. Bernardi, and M. Perchinunno, *Chim. Ind. (Milan)*, 51, 280 (1969).
- (204) F. Minisci, R. Galli, and R. Bernardi, *Chim. Ind. (Milan)*, 49, 594 (1967).
- (205) F. Minisci, G. P. Gardini, and F. Bertini, *Can. J. Chem.*, 48, 544 (1970).
- (206) F. Minisci, R. Galli, A. Galli, and R. Bernardi, *Tetrahedron Lett.*, 2207 (1967).
- (207) F. Minisci, R. Galli, and R. Bernardi, *J. Chem. Soc., Chem. Commun.*, 903 (1967).
- (208) F. Minisci, R. Galli, M. Cecere, and R. Bernardi, *Chim. Ind. (Milan)*, 49, 946 (1967).
- (209) F. Minisci, R. Galli, R. Bernardi, and M. Perchinunno, *Chim. Ind. (Milan)*, 50, 328 (1968).
- (210) R. Bernardi, R. Galli, and F. Minisci, *J. Chem. Soc. B*, 324 (1968).
- (211) F. Minisci, R. Galli, M. Perchinunno, and R. Bernardi, *Chim. Ind. (Milan)*, 50, 453 (1968).
- (212) F. Minisci, R. Galli, A. Galli, and R. Bernardi, *Chim. Ind. (Milan)*, 49, 252 (1967).
- (213) (a) F. Minisci, R. Galli, and R. Bernardi, *Tetrahedron Lett.*, 699 (1966); (b) R. S. Neale and E. Gross, *J. Am. Chem. Soc.*, 89, 6579 (1967); (c) T. Majelsky and Y. L. Chow, *J. Am. Chem. Soc.*, 96, 4549 (1974).
- (214) N. C. Deno, D. G. Pohl, and H. J. Spinelli, *Bioorg. Chem.*, 3, 66 (1974).
- (215) C. V. Smith and W. E. Billups, *J. Am. Chem. Soc.*, 96, 4307 (1974).
- (216) N. C. Deno, R. Fishbein, and J. C. Wyckoff, *J. Am. Chem. Soc.*, 93, 2065 (1971).
- (217) T. Mojelsky and Y. L. Chow, *J. Am. Chem. Soc.*, 96, 4549 (1974).
- (218) Y. L. Chow, C. J. Colon, and S. C. Chen, *J. Org. Chem.*, 32, 2109 (1967).
- (219) R. S. Neale, *J. Org. Chem.*, 32, 3263 (1967).
- (220) Y. L. Chow, J. N. S. Tam, C. J. Colon, and S. K. Pillay, *Can. J. Chem.*, 51, 2469 (1973).
- (221) F. Minisci and R. Galli, *Tetrahedron Lett.*, 3197 (1964).
- (222) R. S. Neale and R. L. Hinman, *J. Am. Chem. Soc.*, 85, 2666 (1963).
- (223) R. S. Neale, *J. Am. Chem. Soc.*, 86, 5340 (1964).
- (224) R. S. Neale, N. L. Marcus, *J. Org. Chem.*, 32, 3273 (1967).
- (225) R. S. Neale and M. L. Marcus, *J. Org. Chem.*, 33, 3457 (1968).
- (226) Y. L. Chow, S. C. Chen, and D. W. L. Chang, *Can. J. Chem.*, 48, 157 (1970).
- (227) Y. L. Chow, S. C. Chen, and T. Mojelsky, *J. Chem. Soc., Chem. Commun.*, 827 (1973).
- (228) H. H. Quon, T. Tezuka, and Y. L. Chow, *J. Chem. Soc., Chem. Commun.*, 428 (1974).
- (229) Y. L. Chow and D. W. L. Chang, *J. Chem. Soc., Chem. Commun.*, 64 (1971).
- (230) Y. L. Chow, S. C. Chen, and D. W. L. Chang, *Can. J. Chem.*, 49, 3069 (1971).
- (231) I. L. Mador and L. J. Rekers, German Patent 1,132,122 (1963); *Chem. Abstr.*, 58, 2369 (1963).
- (232) Y. L. Chow, C. J. Colon, H. H. Quon, and T. Mojelsky, *Can. J. Chem.*, 50, 1065 (1972).
- (233) T. A. Gadzhiev, Z. F. Mamedov, and K. A. Gabelaya, *Azerb. Khim. Zh.*, 89 (1969); *Chem. Abstr.*, 72, 31127n (1970).
- (234) R. W. Lockhart, Ph.D. Thesis, Simon Fraser University, Burnaby, 1975.
- (235) D. W. L. Chang, M.Sc. Thesis, Simon Fraser University, Burnaby, June 1970.
- (236) Y. L. Chow, *Can. J. Chem.*, 43, 2711 (1965).
- (237) E. G. Wyss and O. Schindler, *Helv. Chim. Acta*, 53, 1099 (1970).
- (238) Y. L. Chow, C. J. Colon, and D. W. L. Chang, *Can. J. Chem.*, 48, 1664 (1970).
- (239) J. W. Bastable, J. D. Hobson, and W. D. Riddell, *J. Chem. Soc., Perkin Trans. 1*, 2205 (1972); J. D. Hobson and W. D. Riddell, *Chem. Commun.*, 1178 (1968).
- (240) J. M. Surzur, P. Tordo, and L. Stella, *Bull. Soc. Chim., Fr.*, 111, 115 (1970).
- (241) J. M. Surzur, L. Stella, and P. Tordo, *Tetrahedron Lett.*, 3107 (1970).
- (242) J. M. Surzur, L. Stella, and P. Nauguier, *Tetrahedron Lett.*, 903 (1971).
- (243) J. M. Surzur and L. Stella, *Tetrahedron Lett.*, 2191 (1974).
- (244) Y. L. Chow, R. A. Perry, B. C. Menon, and S. C. Chen, *Tetrahedron Lett.*, 1545 (1971).
- (245) Y. L. Chow, R. A. Perry, and B. C. Menon, *Tetrahedron Lett.*, 1549 (1971).
- (246) (a) R. A. Perry, Ph.D. Thesis, Simon Fraser University, Burnaby, Feb 1974; (b) R. A. Perry, S. C. Chen, B. C. Menon, K. Hanaya, and Y. L. Chow, *Can. J. Chem.*, 54, 2385 (1976).
- (247) M. Julia, *Acc. Chem. Res.*, 4, 386 (1971).
- (248) A. I. J. Beckwith, G. E. Gream, and D. L. Stubble, *Aust. J. Chem.*, 25, 1081 (1972).

- (249) K. Heusler, *Tetrahedron Lett.*, **9**, (1971).
- (250) P. G. Gassman, *Acc. Chem. Res.*, **3**, 26 (1970).
- (251) P. G. Gassman, F. Hoyda, and J. Dygos, *J. Am. Chem. Soc.*, **90**, 2716 (1968).
- (252) P. G. Gassman and J. Dygos, *Tetrahedron Lett.*, 4745 (1970).
- (253) (a) O. E. Edwards, G. Bernath, J. Dixon, J. M. Paton, and D. Vocelle, *Can. J. Chem.*, **52**, 2123 (1974); (b) P. G. Gassman, K. Uneyama, and J. L. Hahnfeld, *J. Am. Chem. Soc.*, **99**, 647 (1977).
- (254) F. Minisci, *Chim. Ind. (Milan)*, **49**, 705 (1967).
- (255) F. Minisci, R. Bernardi, L. Grippa, and V. Trabucchi, *Chim. Ind. (Milan)*, **48**, 264 (1966).
- (256) F. Minisci, *Chim. Ind. (Milan)*, **49**, 705 (1967).
- (257) F. Minisci, R. Galli, R. Bernardi, and A. Galli, *Chim. Ind. (Milan)*, **49**, 387 (1967).
- (258) F. Minisci, V. Trabucchi, R. Galli, and R. Bernardi, *Chim. Ind. (Milan)*, **48**, 845 (1966).
- (259) F. Minisci and R. Galli, *Tetrahedron Lett.*, 2532 (1966).
- (260) G. Adam and K. Schreiber, *Tetrahedron*, **22**, 3591 (1966).
- (261) S. K. Malhotra, J. J. Hostynek, and A. F. Lundin, *J. Am. Chem. Soc.*, **90**, 6565 (1968).
- (262) The aldehydes must be removed from solution rapidly to avoid further oxidation. See B. R. Eiggins and V. Q. Chambers, *Chem. Commun.*, 232, 1267 (1969).
- (263) (a) W. R. Turner and P. J. Elving, *J. Electrochem. Soc.*, **112**, 233 (1965); (b) N. L. Weinberg and H. R. Weinberg, *Chem. Rev.*, **68**, 441 (1968).
- (264) S. Mizino, Y. Hirata, and K. Takei, *J. Electrochem. Soc. Jpn. Overseas Ed.*, **29**, 31 (1961); *Chem. Abstr.*, **60**, 11889 (1964).
- (265) M. Y. Koyama and K. Yamamoto, *Bull. Soc. Chem. Jpn.*, **8**, 306 (1933).
- (266) R. F. Drapo and C. K. Mann, *Anal. Chem.*, **35**, 677 (1963).
- (267) C. D. Russell, *Anal. Chem.*, **35**, 1291 (1963).
- (268) R. A. Benkeser, E. M. Kaiser, and R. F. Lambert, *J. Am. Chem. Soc.*, **86**, 5272 (1964).
- (269) K. K. Barnes and C. K. Mann, *J. Org. Chem.*, **32**, 1474 (1967).
- (270) (a) C. P. Andrieux and J. M. Saveant, *Bull. Soc. Chim. Fr.*, 4671 (1968); (b) *ibid.*, 1254 (1969).
- (271) P. J. Smith and C. K. Mann, *J. Org. Chem.*, **34**, 182 (1969).
- (272) (a) L. C. Portis, V. V. Bhat, and C. K. Mann, *J. Org. Chem.*, **35**, 2175 (1970); (b) S. D. Ross, *Tetrahedron Lett.*, 1237 (1973).
- (273) M. Masui and H. Sayo, *Tetrahedron Lett.*, 1593 (1971).
- (274) N. L. Weinberg and E. A. Brown, *J. Org. Chem.*, **31**, 4058 (1966).
- (275) P. J. Smith and C. K. Mann, *J. Org. Chem.*, **33**, 316 (1968).
- (276) N. L. Weinberg, *J. Org. Chem.*, **33**, 4326 (1968).
- (277) N. A. Hampson, J. B. Lee, and K. I. MacDonald, *Electrochim. Acta*, **17**, 92 (1972).
- (278) N. A. Hampson, J. B. Lee, J. R. Morley, and B. Scanlon, *Can. J. Chem.*, **47**, 3729 (1969).
- (279) N. A. Hampson, J. B. Lee, J. R. Morley, K. I. MacDonald, and B. Scanlon, *Tetrahedron*, **26**, 1109 (1970).
- (280) M. Fleischmann, K. Korinek, and D. Pletcher, *J. Chem. Soc., Perkin Trans. 2*, 1396 (1972).
- (281) A. Weller, *Chem. Kinet. Proc. Nobel Symp.*, **5**, 413 (1967).
- (282) A. Weller, *Pure Appl. Chem.*, **16**, 115 (1968).
- (283) S. G. Cohen and J. I. Cohen, *J. Am. Chem. Soc.*, **89**, 164 (1967); *J. Phys. Chem.*, **72**, 3782 (1968).
- (284) S. G. Cohen and H. M. Chao, *J. Am. Chem. Soc.*, **90**, 165 (1968).
- (285) J. B. Guttenplan and S. G. Cohen, *J. Am. Chem. Soc.*, **94**, 4040 (1972); *Tetrahedron Lett.*, 2163 (1972); S. G. Cohen and J. B. Guttenplan, *ibid.*, 5353 (1968).
- (286) G. A. Davis, P. A. Carapellucci, K. Szoc, and J. D. Gresser, *J. Am. Chem. Soc.*, **91**, 2264 (1969).
- (287) R. F. Bartholomew, R. S. Davidson, and M. J. Howell, *J. Chem. Soc. C*, 2804 (1971).
- (288) S. G. Cohen and N. M. Stein, *J. Am. Chem. Soc.*, **93**, 6542 (1971).
- (289) S. G. Cohen and A. D. Litt, *Tetrahedron Lett.*, 837 (1970).
- (290) S. G. Cohen and J. B. Guttenplan, *Tetrahedron Lett.*, 5353 (1968).
- (291) R. S. Davidson, P. F. Lambeth, and M. Santhanam, *J. Chem. Soc., Perkin Trans. 2*, 237 (1972).
- (292) G. H. Parson, L. T. Mendelson, and S. G. Cohen, *J. Am. Chem. Soc.*, **96**, 6643 (1974).
- (293) G. H. Parson and S. G. Cohen, *J. Am. Chem. Soc.*, **96**, 2948 (1974).
- (294) R. W. Yip, R. O. Loutify, Y. L. Chow, and L. K. Magdzinski, *Can. J. Chem.*, **50**, 3626 (1972); J. B. Bianchi and A. R. Watkins, *J. Chem. Soc., Chem. Commun.*, 265 (1974).
- (295) R. S. Davidson, P. F. Lambeth, F. A. Younis, and R. Wilson, *J. Chem. Soc. C*, 2203 (1969).
- (296) S. Arimitsu and H. Masuhara, *Chem. Phys. Lett.*, **22**, 543 (1973).
- (297) R. F. Bartholomew, R. S. Davidson, P. F. Lambeth, J. F. McKeller, and P. F. Turner, *J. Chem. Soc., Perkin Trans. 2*, 577 (1972).
- (298) S. G. Cohen and B. Green, *J. Am. Chem. Soc.*, **91**, 6824 (1969).
- (299) A. Padwa, W. Eisenhardt, R. Gruber, and D. Pashayan, *J. Am. Chem. Soc.*, **91**, 1857 (1969).
- (300) P. J. Wagner and A. E. Kemppainen, *J. Am. Chem. Soc.*, **91**, 3085 (1969).
- (301) A. Padwa, F. Albrecht, P. Singh, and E. Vega, *J. Am. Chem. Soc.*, **93**, 2928 (1971).
- (302) R. S. Davidson and S. P. Orton, *J. Chem. Soc., Chem. Commun.*, 209 (1974).
- (303) M. Ohashi, K. Tsujimoto, and K. Seki, *J. Chem. Soc., Chem. Commun.*, 384 (1973).
- (304) J. R. Lindsay Smith, R. O. C. Norman, and A. G. Rowley, *J. Chem. Soc., Perkin Trans. 1*, 566 (1973).
- (305) R. W. Alder, R. B. Sessions, J. M. Mellor, and M. F. Rawlins, *J. Chem. Soc., Chem. Commun.*, 747 (1977).